

# The Façade: Our Third Skin

Examples to Inspire and Question!

## Façade – definition

Noun:

The face of a building, especially the principal front that looks onto a street or open space

Your choice of skin/ façade will be **CLIMATE  
DEPENDENT**

The type of building – commercial,  
institutional, residential matters

The amount of insulation needed responds to  
both climate and building use

The façade or skin is a huge part of the budget

The Façade will be where you “read” the “style” of a building

- Greek, Roman, Gothic, Neo-Classical, Modern, Deconstructivist, for example

Generally we can divide them into:

## Symmetrical vs Non-symmetrical styles

- Generally HISTORIC styles were symmetrical
- Modern architecture decided symmetry was "out" (too old fashioned)

In all cases there are conscious  
"control lines" by which the  
façade is organized.

Some of these will relate to the  
sill and head height of windows.

For early stone and masonry buildings the load bearing, solid walls of the building also presented the appearance or façade of the building.

The style and the structural system were joined.



Notre Dame de Paris,  
France  
1113 CE





Bibliothèque Sainte-Geneviève  
Paris, France  
Henri Labrouste  
1835-1851





Monadnock Building (north half)  
Chicago, Illinois  
Burnham and Root  
1891

The invention of the **skeleton steel frame** at the end of the 1800s separated the roles of the structure and enclosure system.

The enclosure system took on the role of façade and had much more freedom of expression as it did not have to also support the loads of the building.

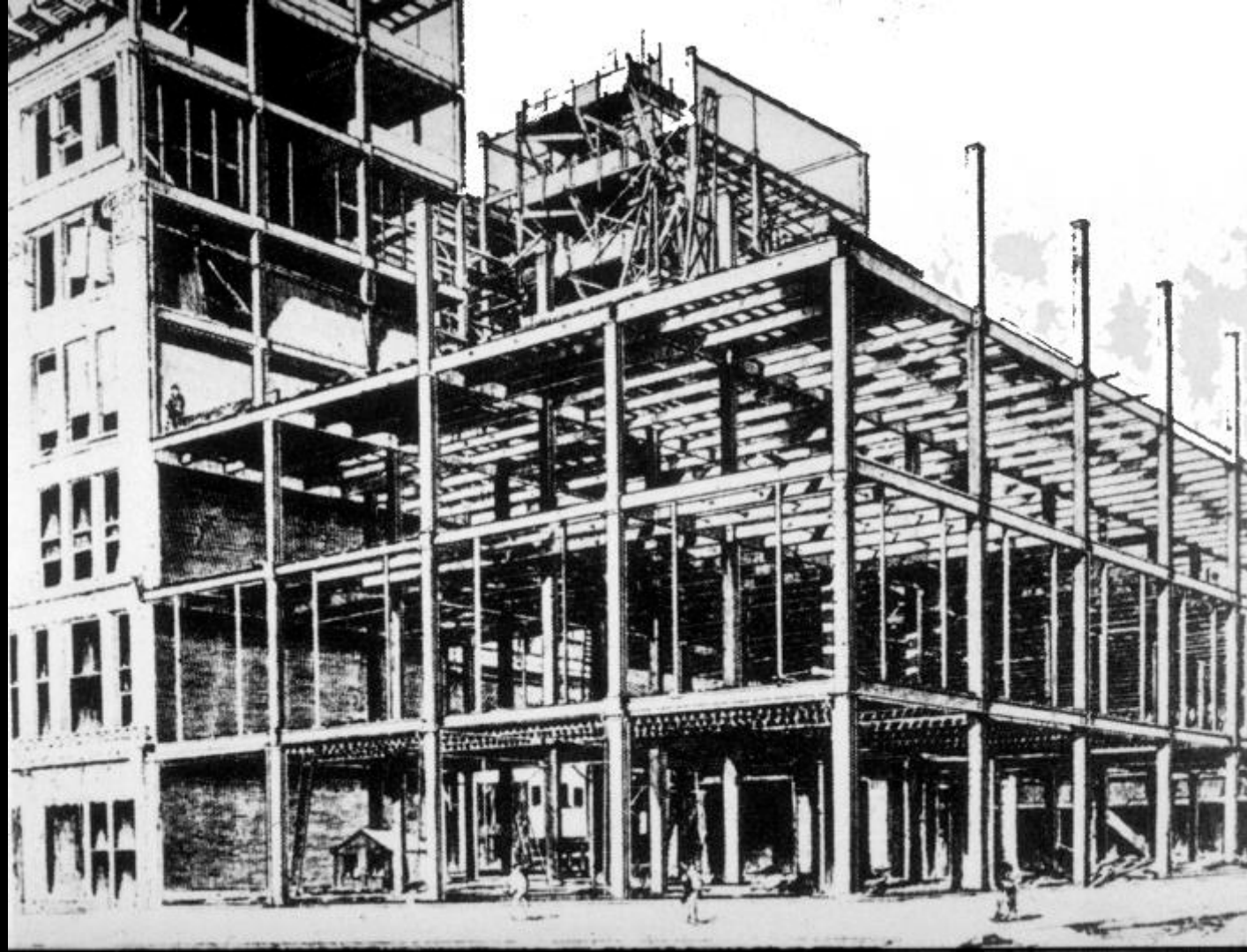



Reliance Building  
Chicago, Illinois  
Burnham, Root and  
Atwood  
1895  
First real skyscraper



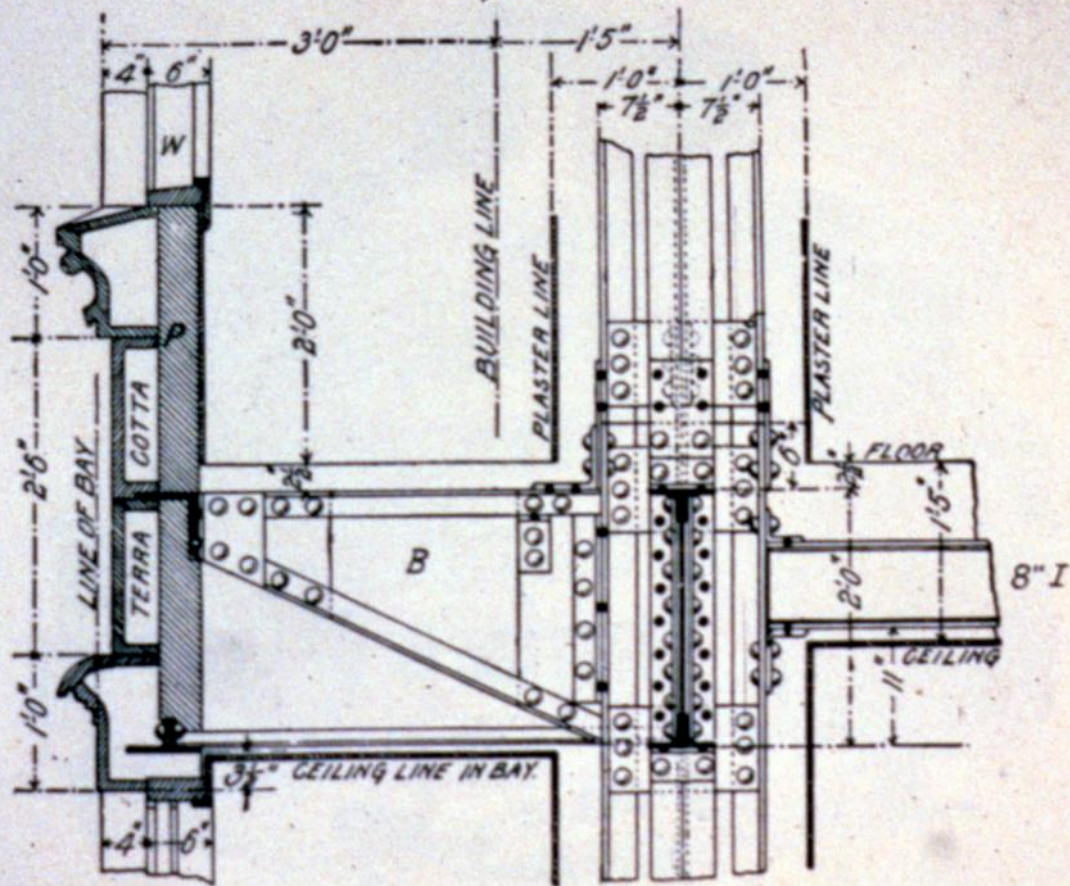

27 Atwood and Burnham, Reliance Building,  
Chicago, 1890/94-95. Cross section of window bay.

Different approaches to the construction of the enclosures for tall vs mid-rise vs low-rise *commercial* buildings

**Tall** = curtain wall

**Mid-rise** = less use of aluminum curtain wall and more composite layered systems with insulation

**Low-rise** = composite layered systems with more insulation requirements



## Low-rise (mostly residential)

- Load bearing framed walls
- Insulation contained between the studs
- Glazed openings punched in the wall

Exterior cladding is a “veneer” that keeps out the weather but does not support the floors and roof

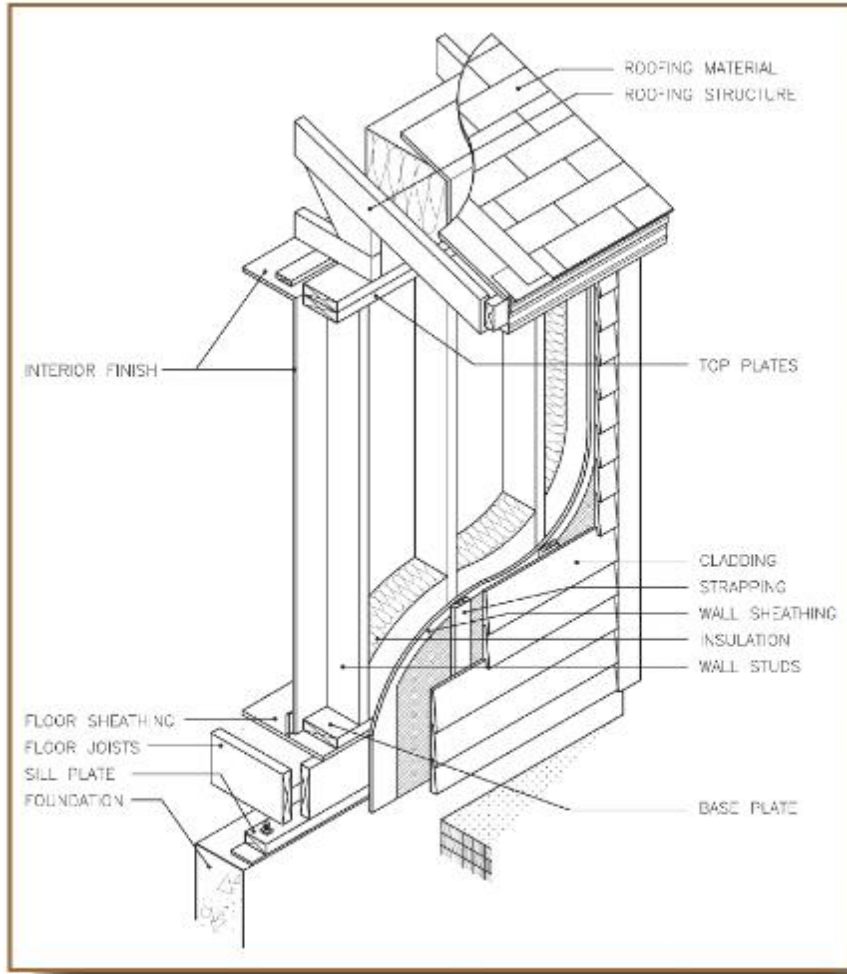
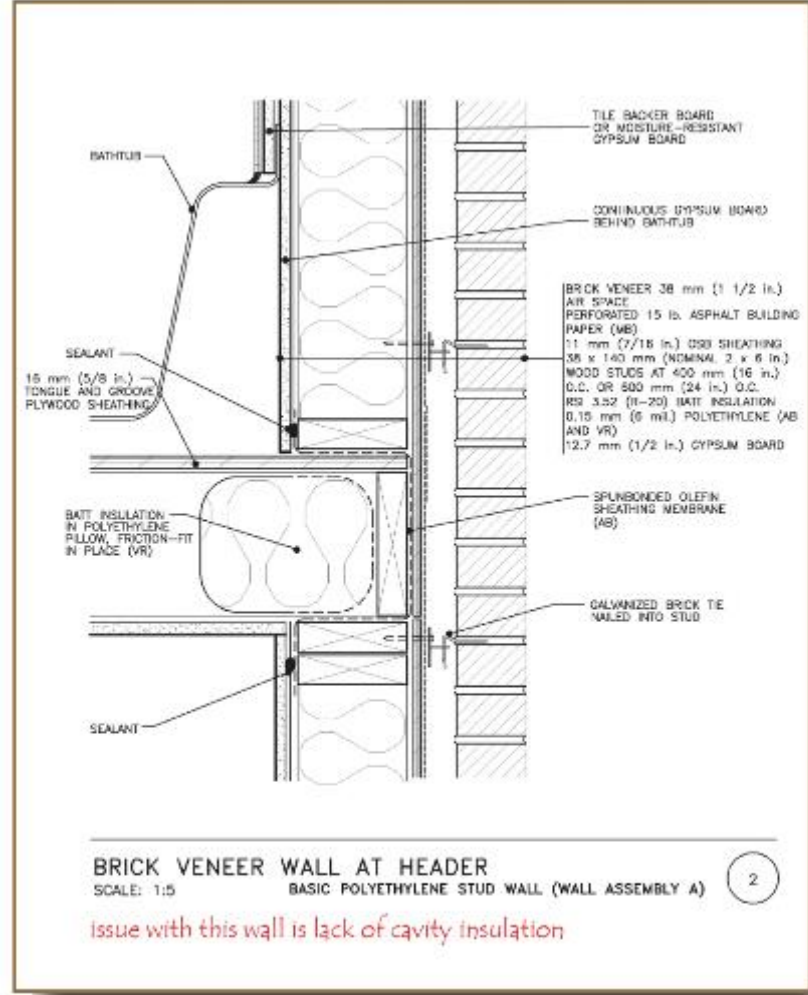

Figure 2.6: Components of a wood frame structure



Detail 2: Brick Veneer Wall at Header

## Rain Screen:

In the 1960s an improved wall system was developed that placed an air space behind the outermost layer of the envelope system.

This equalized the pressure on either side of this "veneer" and prevented rain from penetrating to the interior part of the wall.

In the 1950s a new curtainwall enclosure system was developed based on a modular system of aluminum components that allowed large expanses of glazing.





For **column and beam** type structures (non load bearing walls) it doesn't matter if the material is steel, concrete or heavy timber, the structure gets erected first, then the curtain wall/window wall is installed.









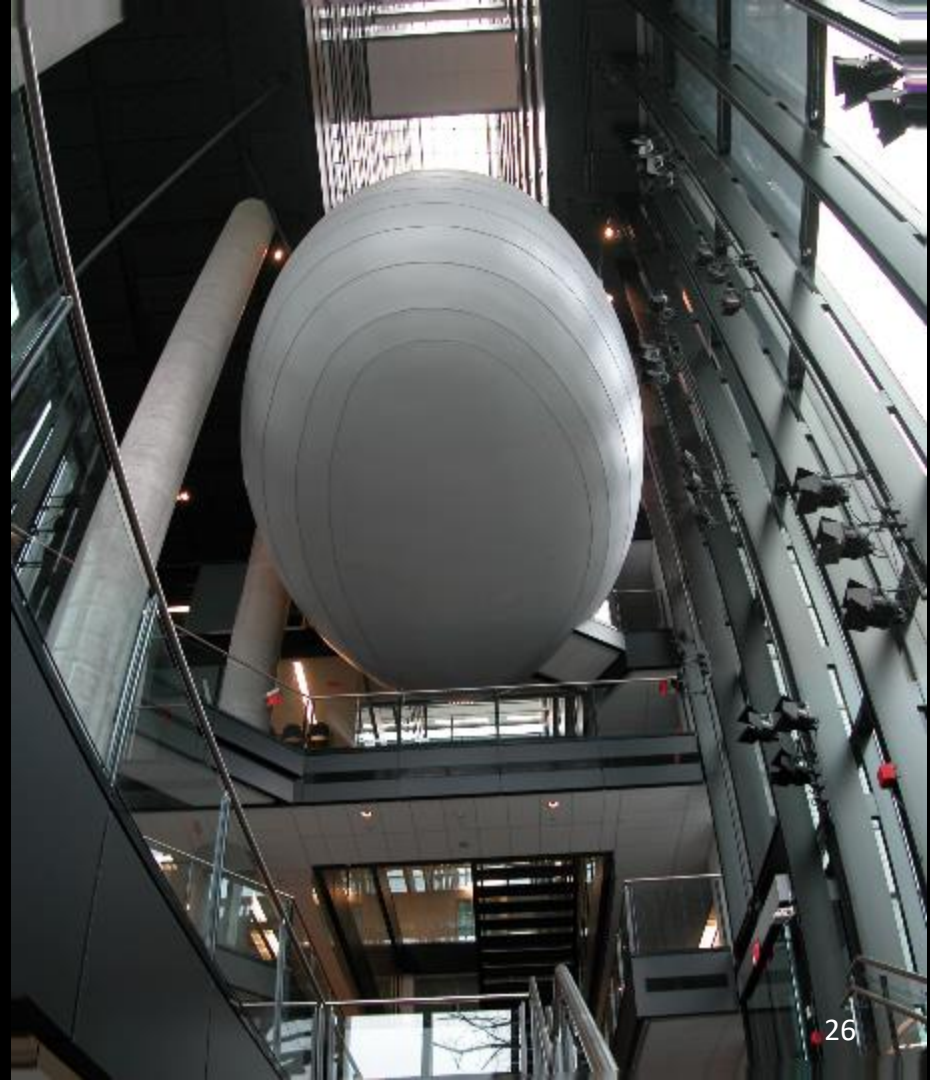





ONE HUDSON  
28  
EDREN









The curtain wall connects to the slab edge NOT the columns





Veer Towers  
Las Vegas, Nevada  
Murphy Jahn Architects  
2010







Swiss Re (The Gherkini)  
London, England  
Foster and Partners  
2004





CCTV Tower  
Beijing, China  
OMA/Rem Koolhaas  
2013











Pearl River Tower  
Guangzhou, China  
SOM  
2013















20 Fenchurch Street  
Aka The Walkie Talkie Building  
London, England  
Rafael Vinoly Architects  
2014











CNOOC Headquarters  
Beijing, China  
Kohn Pederson Fox Architects





Typical curtain wall systems for commercial buildings were always sealed – no operable windows

Due to interest in sustainability, now looking for ways to include access to fresh air into the envelope design, while maintaining safety from falling.















Bahn Tower  
Berlin, Germany  
Murphy Jahn  
2000













## Window Wall:

This type of enclosure for high rise buildings does not use an expansive grid of aluminum frames.

Typically has horizontal bands of windows supported by bands of precast concrete, stone, masonry or metal cladding panels.

In **window wall** construction the infill opaque wall sits (bears) on the edge of the concrete floor slab

It extends to the underside of the next floor, with a small space to allow for slab edge deflections.

Brick Veneer  
Air Space  
Insulation  
Air Bloc 21 or O6  
Concrete Masonry Unit  
Furring  
Gypsum Board

Blueskin® AG  
Thru-Wall Flashing  
Sheet

Air Bloc 21

Blueskin® SA or AG  
Transition Sheet

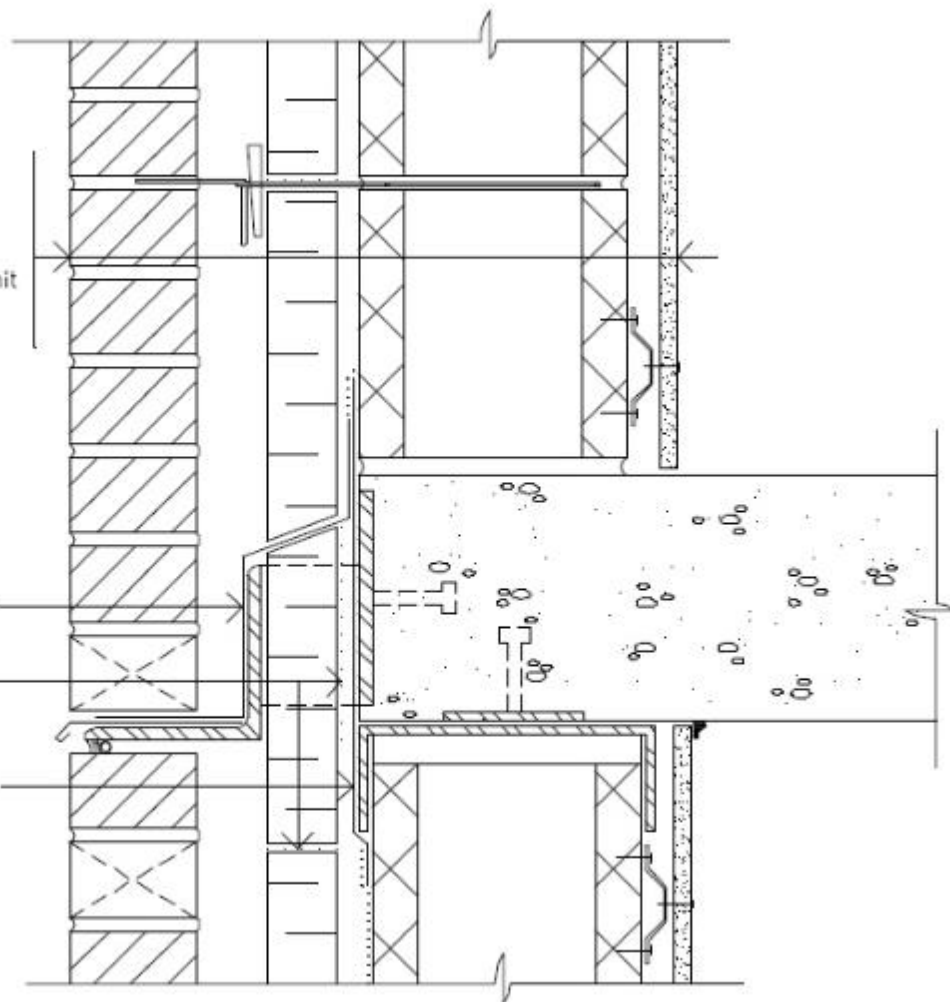

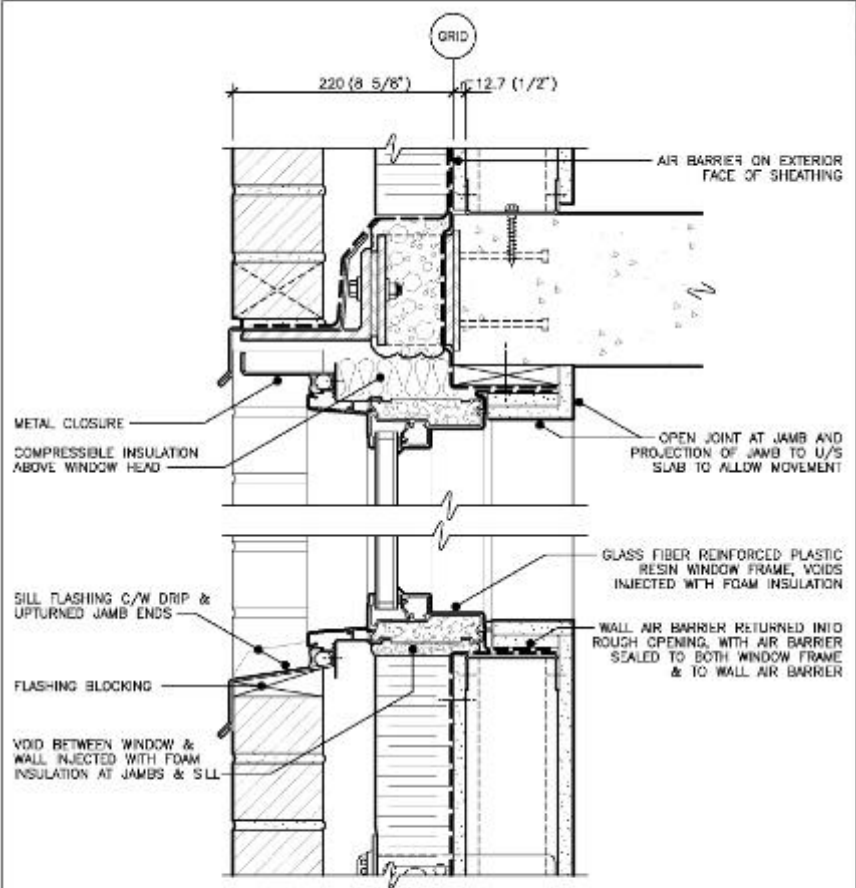

4 WINDOW AT U/S SLAB DETAIL

1' 0" 4" 8"  
 30mm 0 1'00 203mm

## Which to use?

### CURTAIN WALL

- Regular geometry
- Large expanses of glazing
- Limited use of opaque elements
- Typical aluminum frame systems spanning one to two floors height
- Lower insulation values achieved

### WINDOW WALL

- Any kind of geometry
- Limited glazing
- Glazing often as punched or strip windows
- Large opaque portions
- Better insulation levels required



## Thermal Bridge

A VERY BAD place in the building envelope that allows HEAT to ESCAPE

No insulation layer preventing heat flow

Usually happens at concrete slab edges







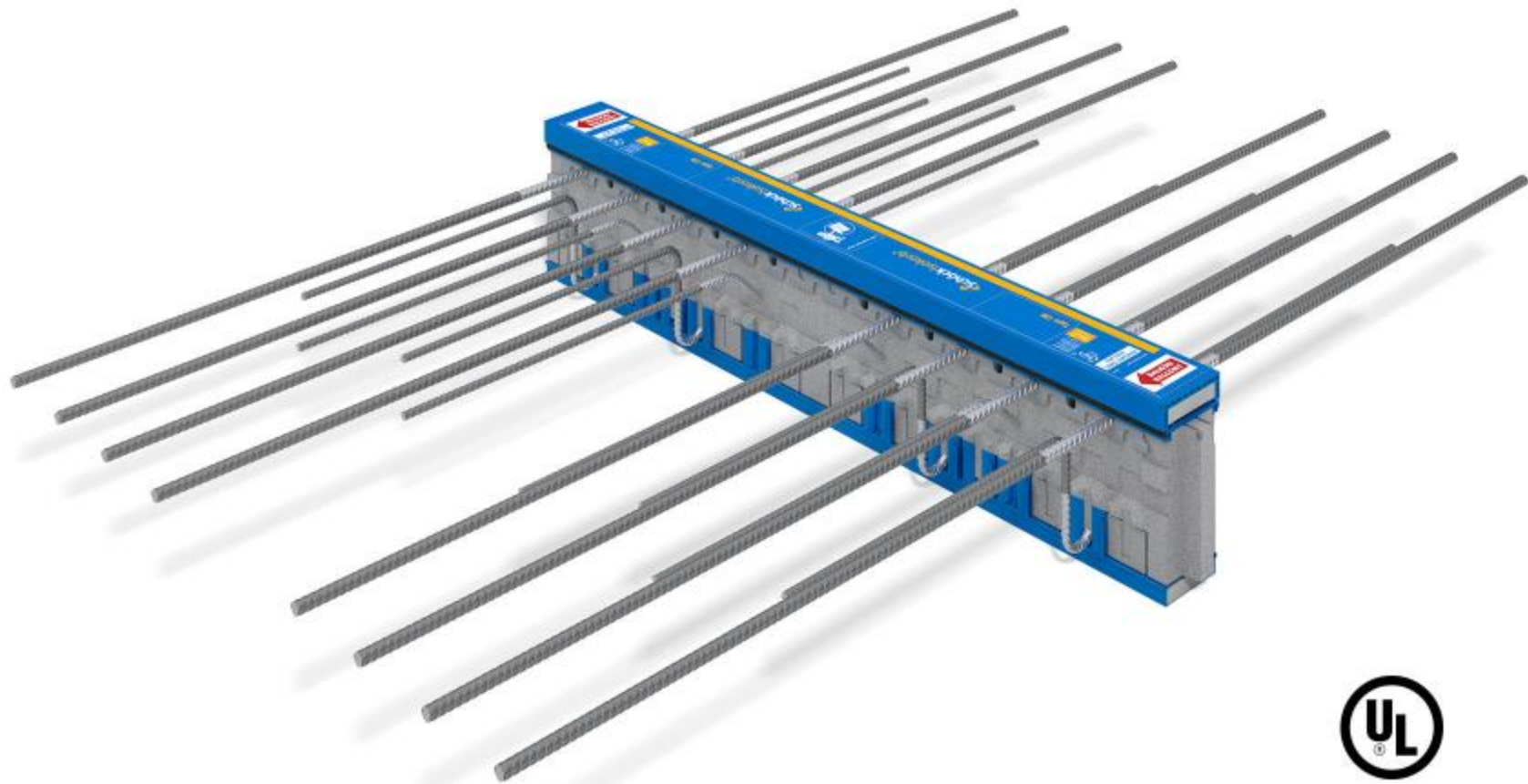





























Residence  
Roger Williams University  
Bristol, Rhode Island  
Perkins + Will Architects











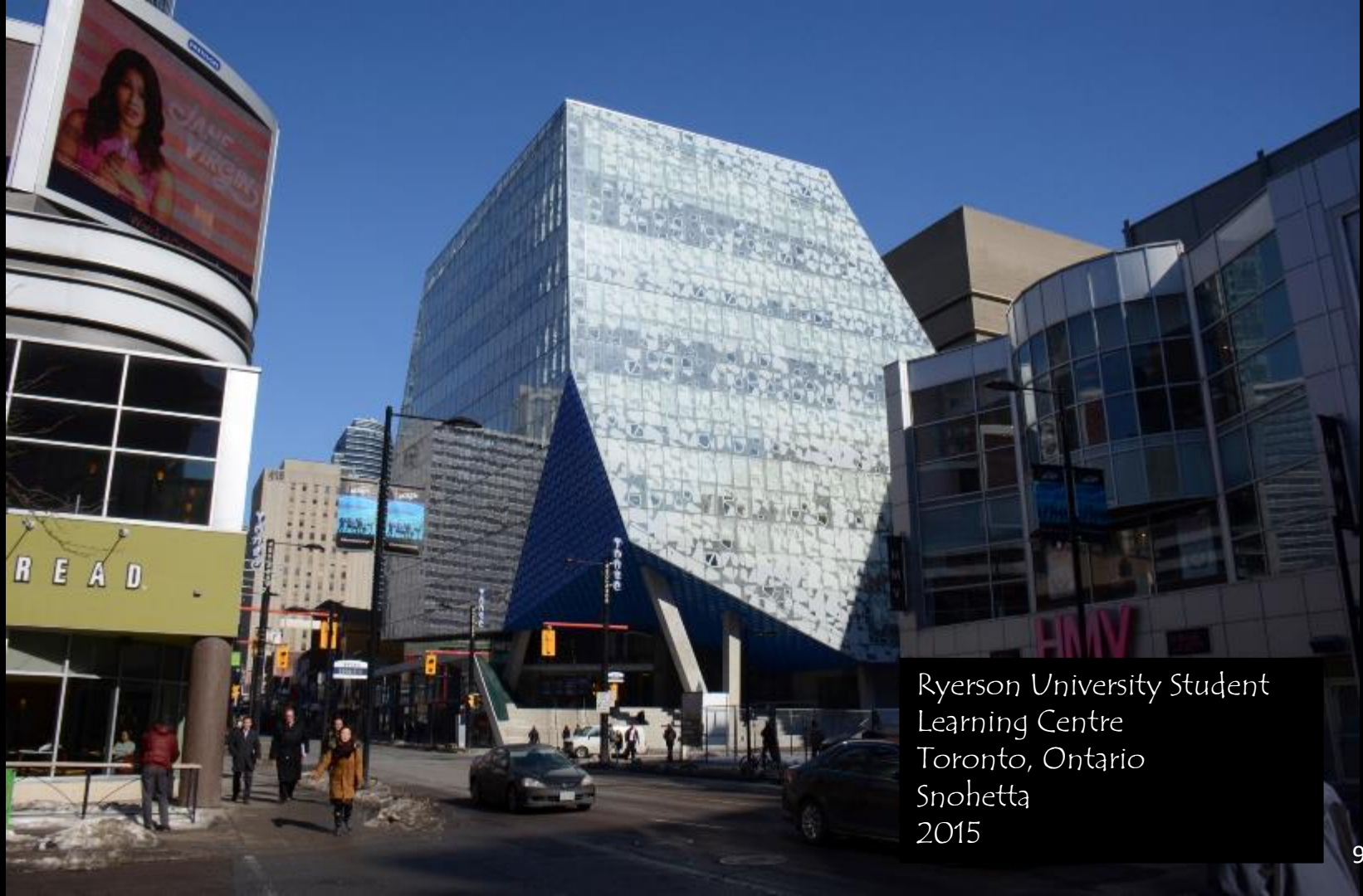

Ryerson University Student Learning Centre  
Toronto, Ontario  
Snohetta  
2015











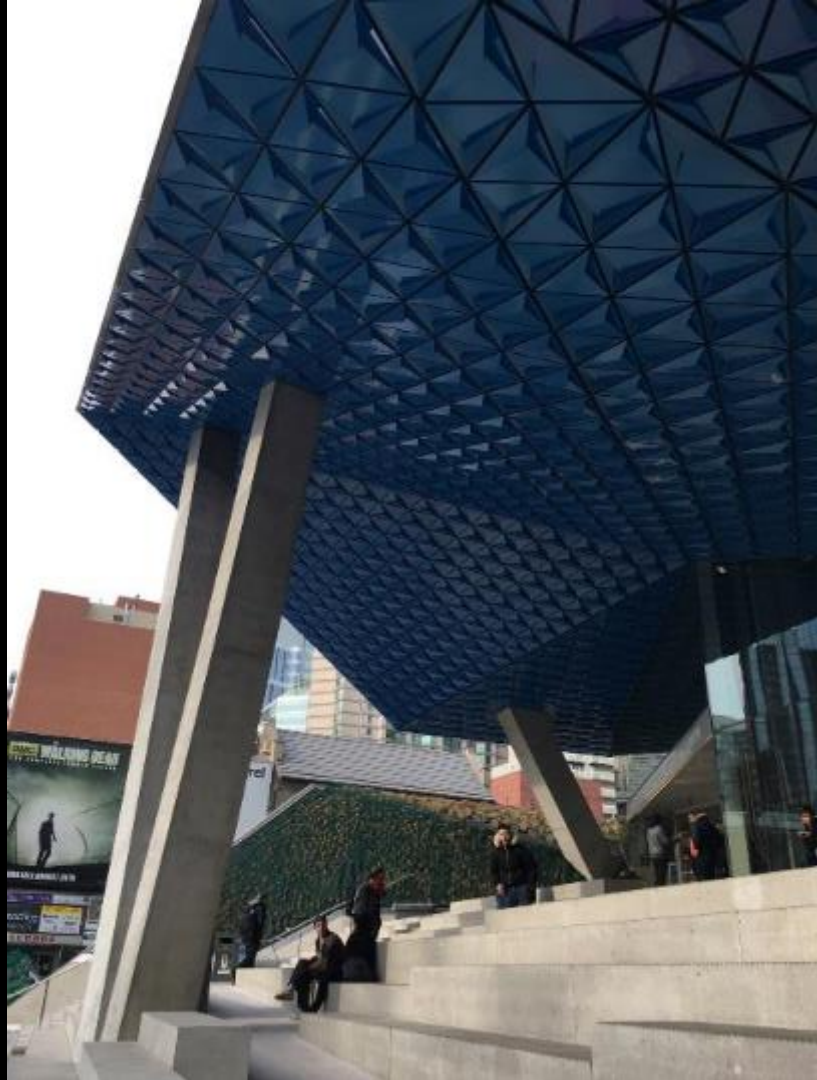





School of Architecture  
Penn State University  
WTW Architects





















Office Building  
Potsdamer Platz  
Berlin, Germany  
Richard Rogers















































St. Giles Complex  
London, England  
Renzo Piano

















# Thin Metal Cladding / Veneer



Residential Building  
Berlin, Germany  
Zaha Hadid









Linked Hybrid  
Beijing, China  
Steven Holl Associates  
2009











Galaxy Soho  
Beijing, China  
Zaha Hadid



















Conrad Hotel  
MAD Architects  
Beijing, China









# Shading Motivated Systems





























Al Bahar Towers  
Abu Dhabi, UAE  
Aedas Architects  
2012

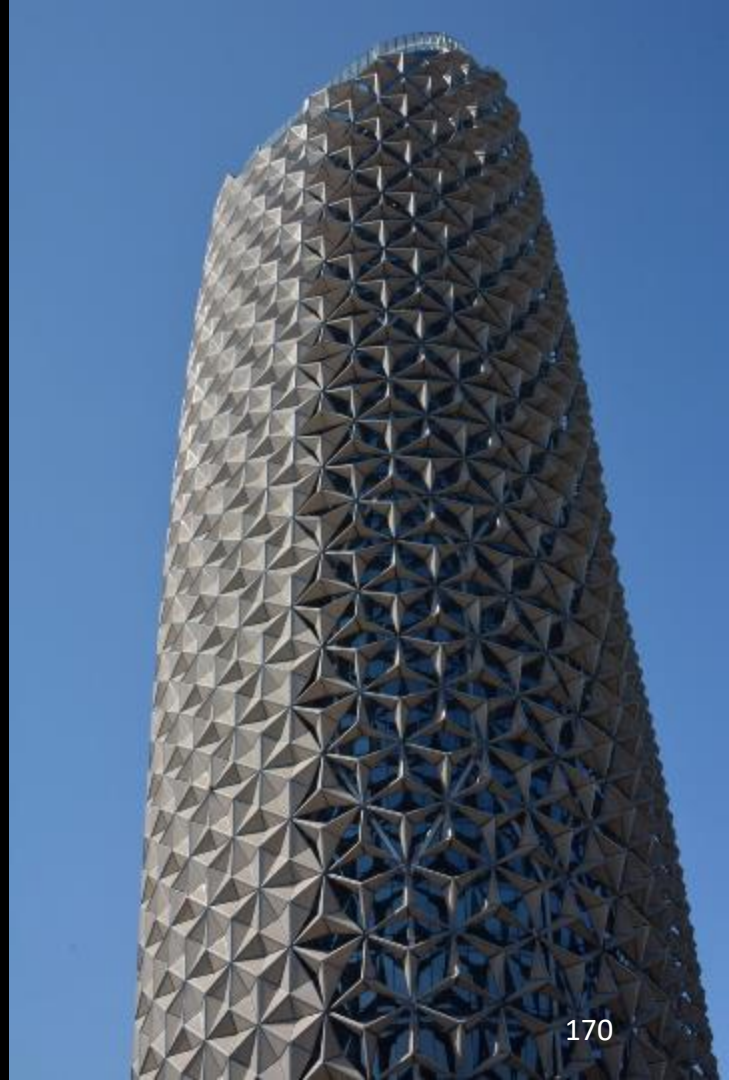









Education City  
Doha, Qatar



















Al Noor Butterfly Pavilion  
Sharjah, UAE  
3deluxe Architects  
2015

















Doha Tower  
Doha, Qatar  
Jean Nouvel Architect  
2012



Doha Tower  
Doha, Qatar  
Jean Nouvel  
2012







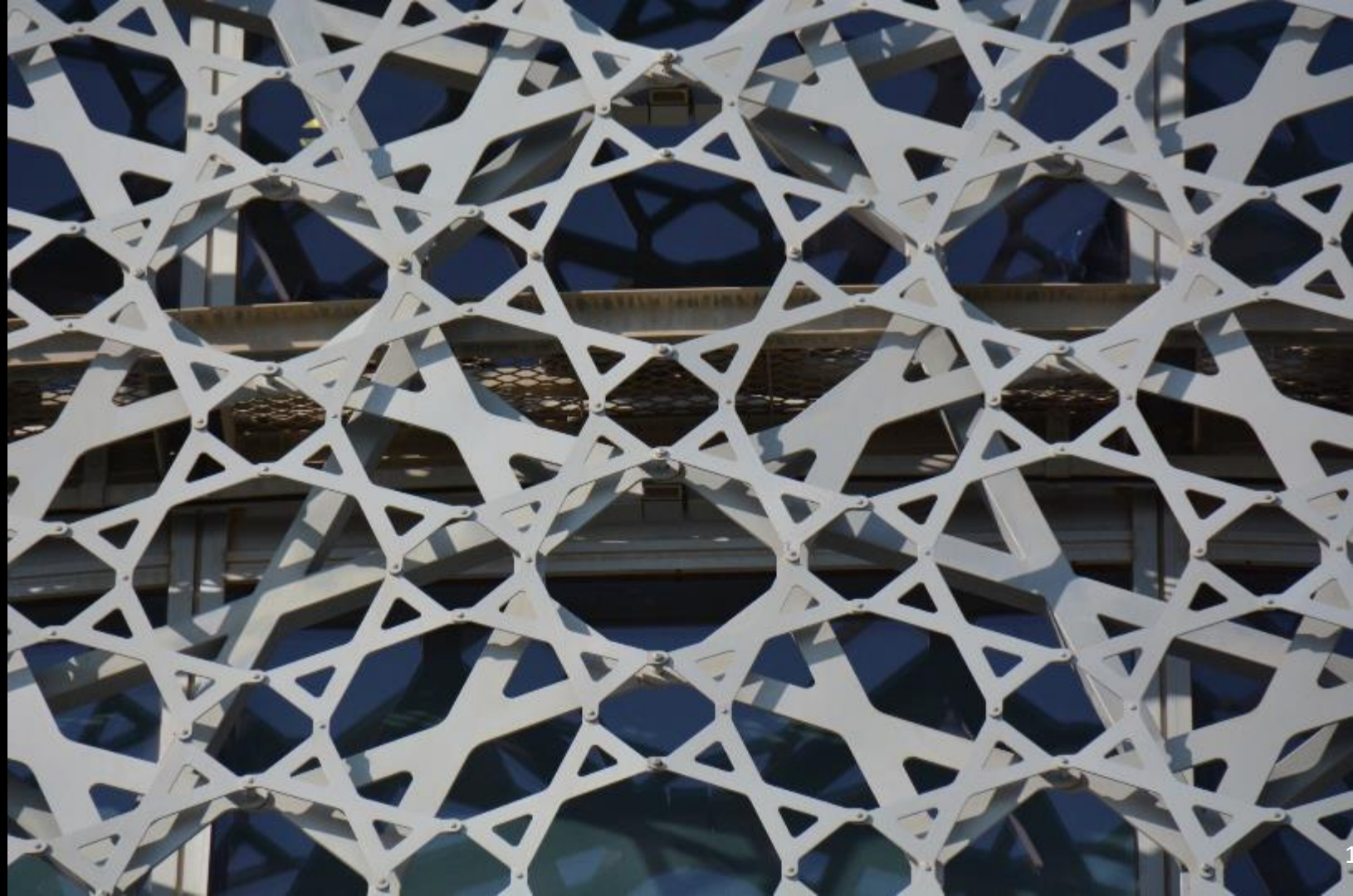











*Various  
Melbourne, Australia*







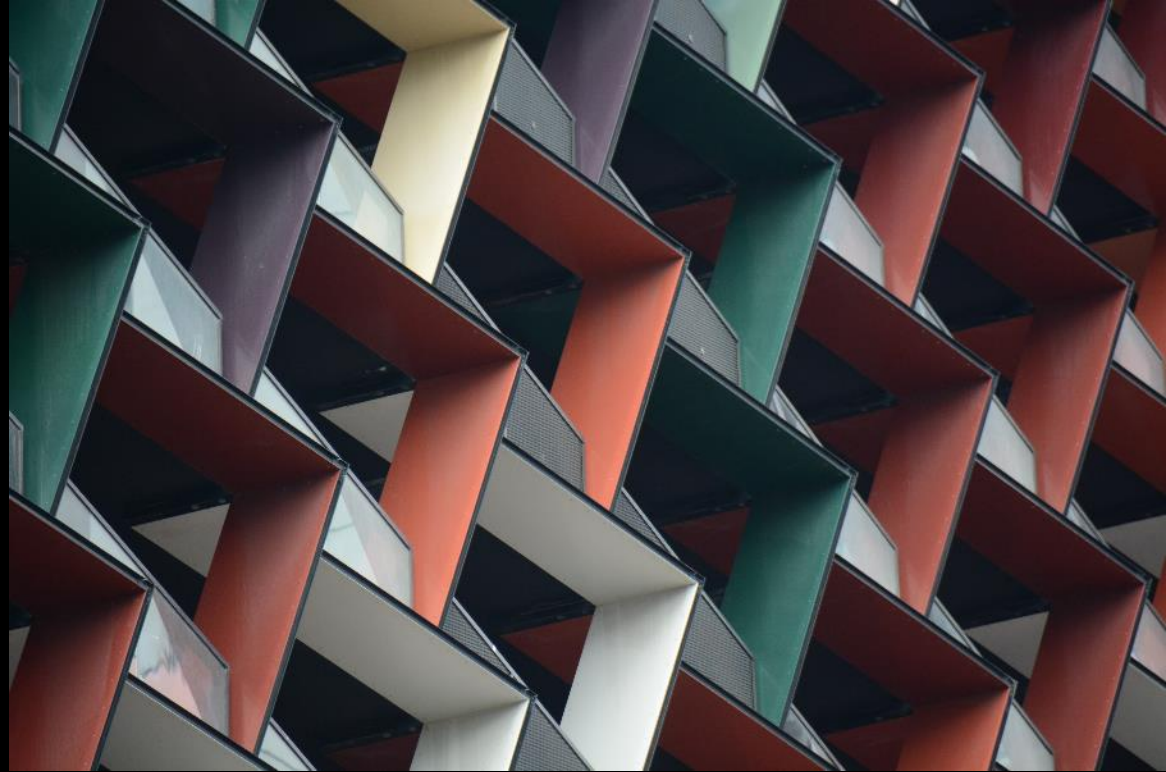

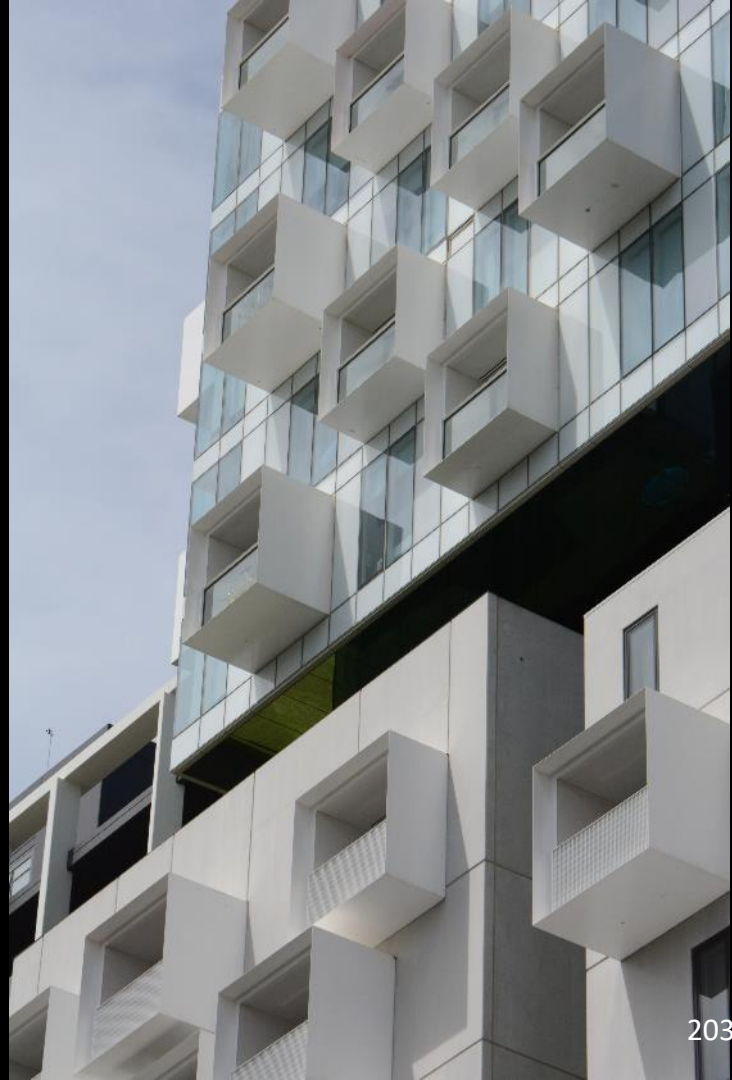





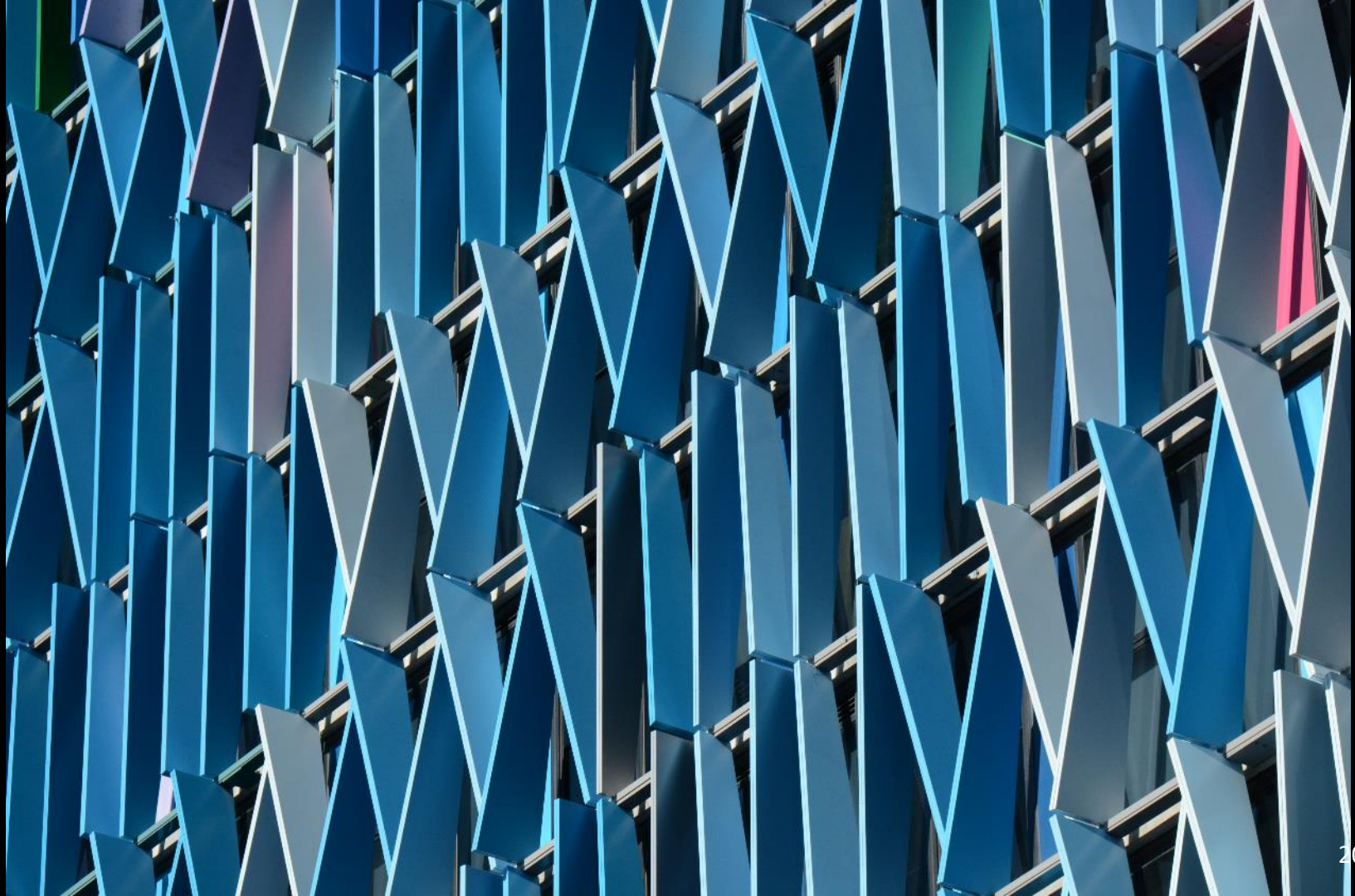

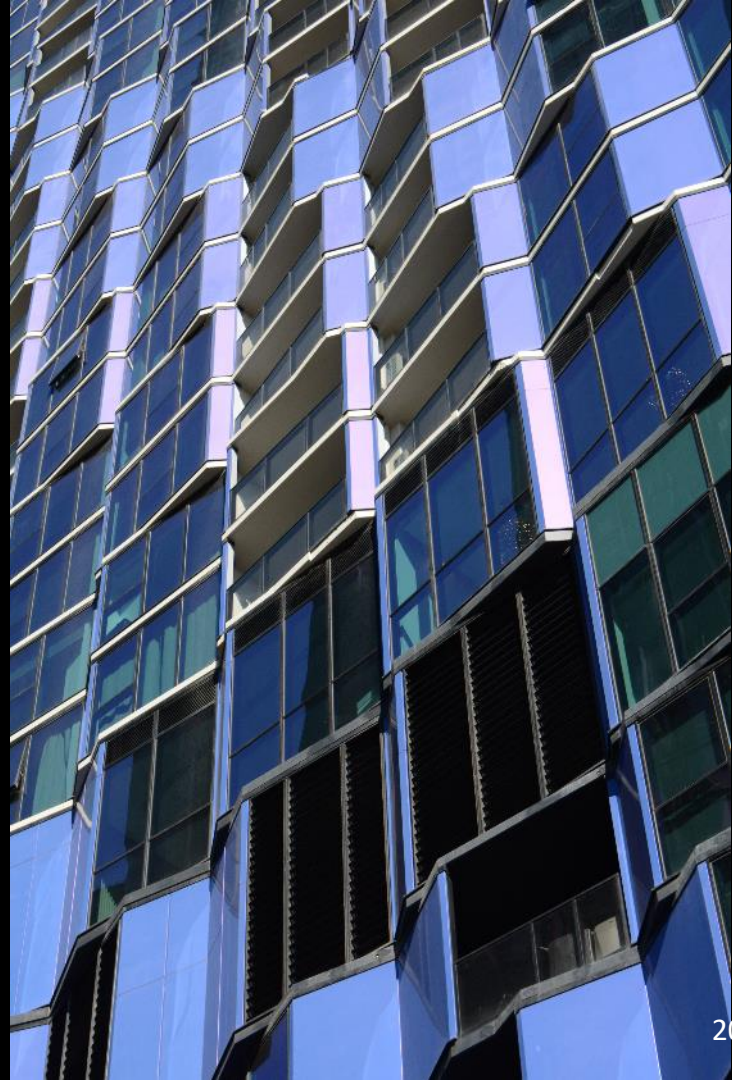

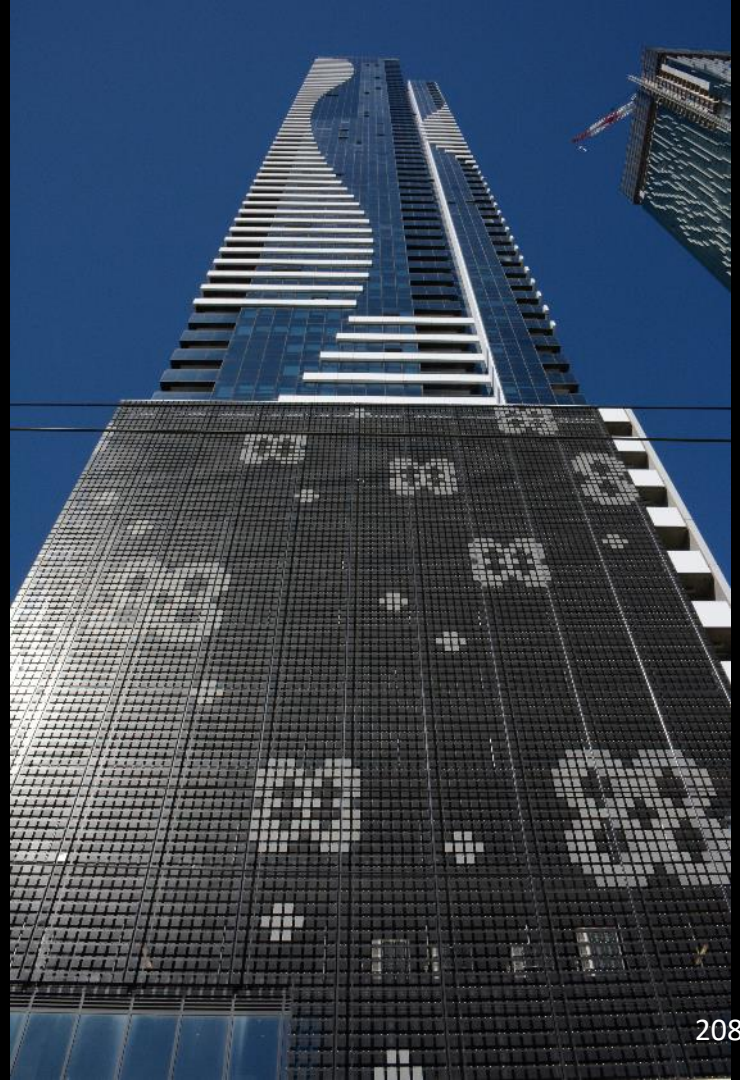
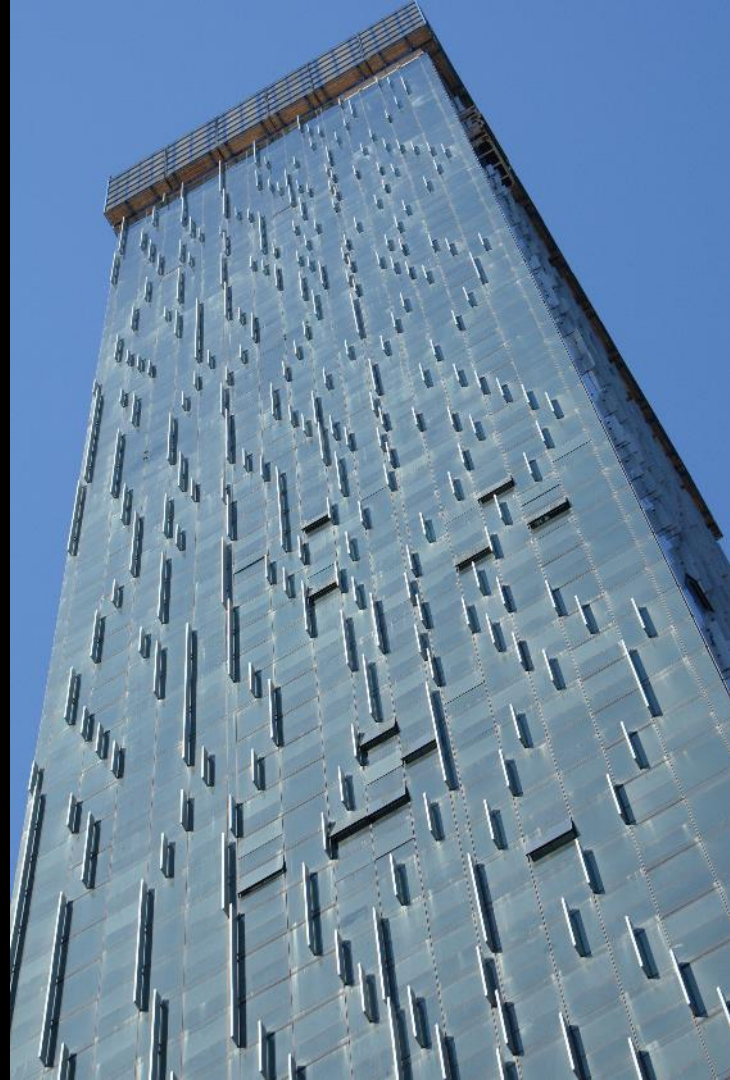









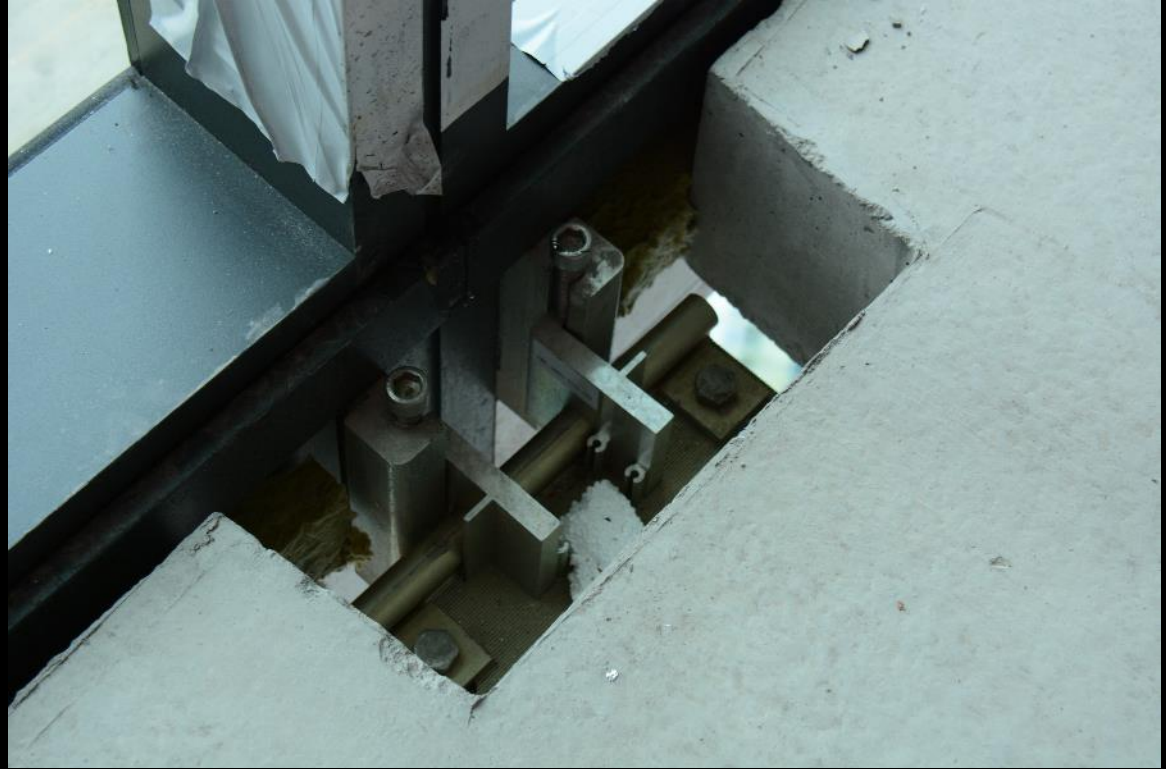



























Royal Melbourne Institute of  
Technology  
Accounting Building  
Melbourne, Australia  
Lyons Architects





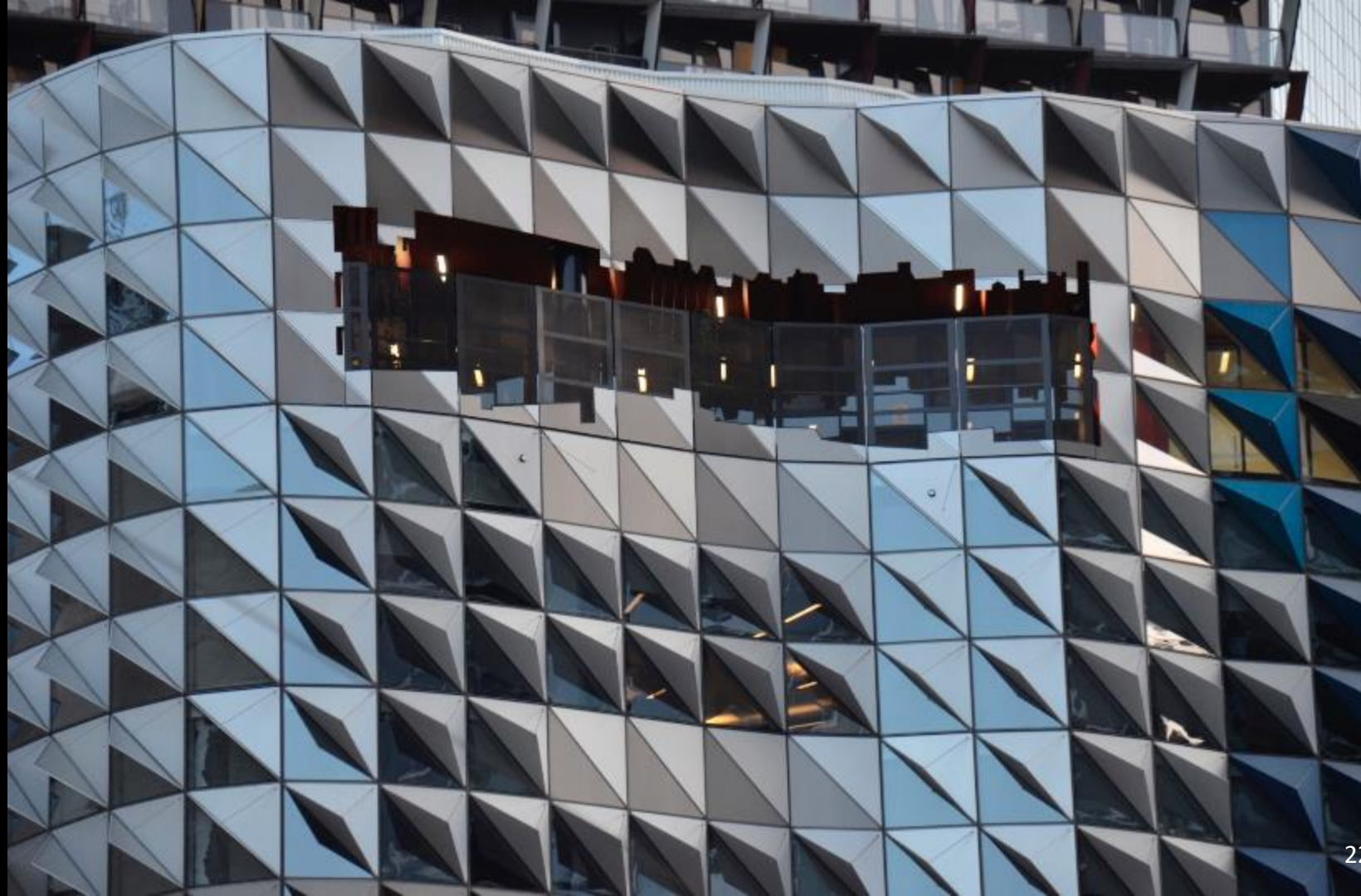

























Pixel Building  
Melbourne, Australia  
Studio 505





















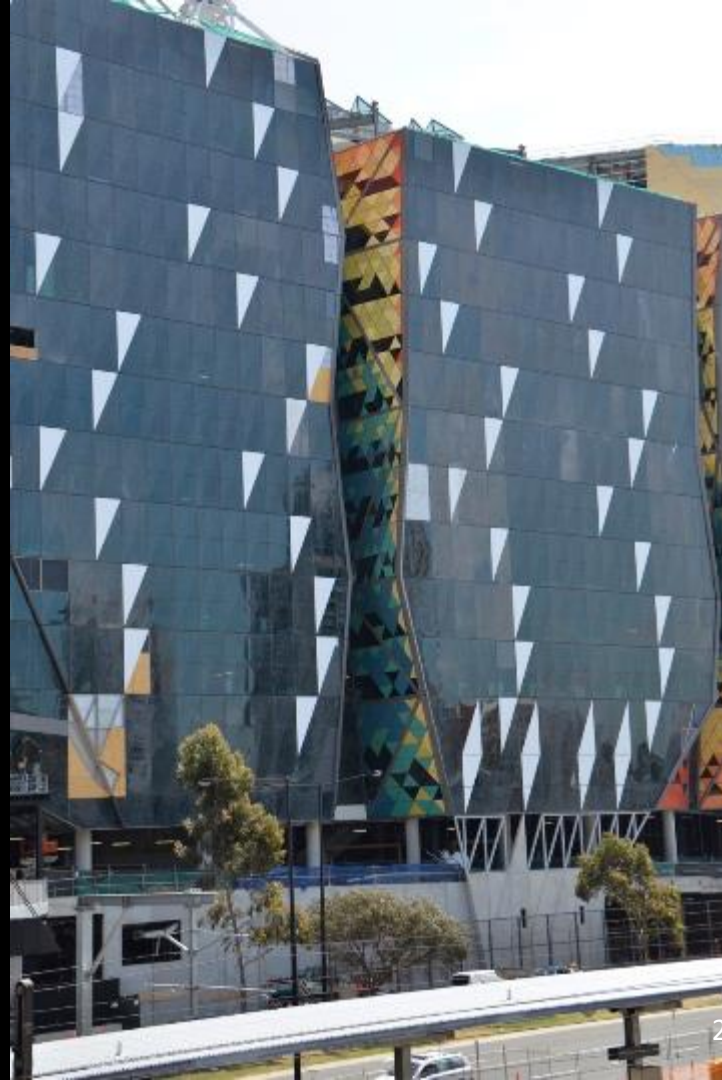

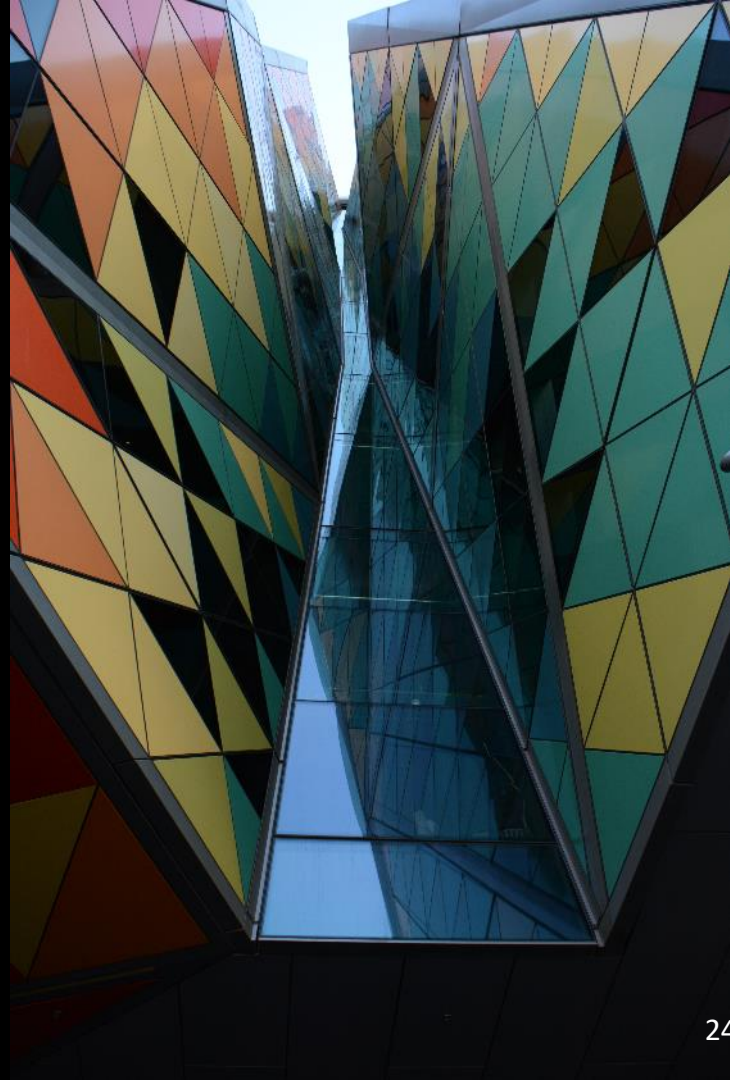





RMIT Design Hub  
Melbourne, Australia  
Peddle Thorp Architects

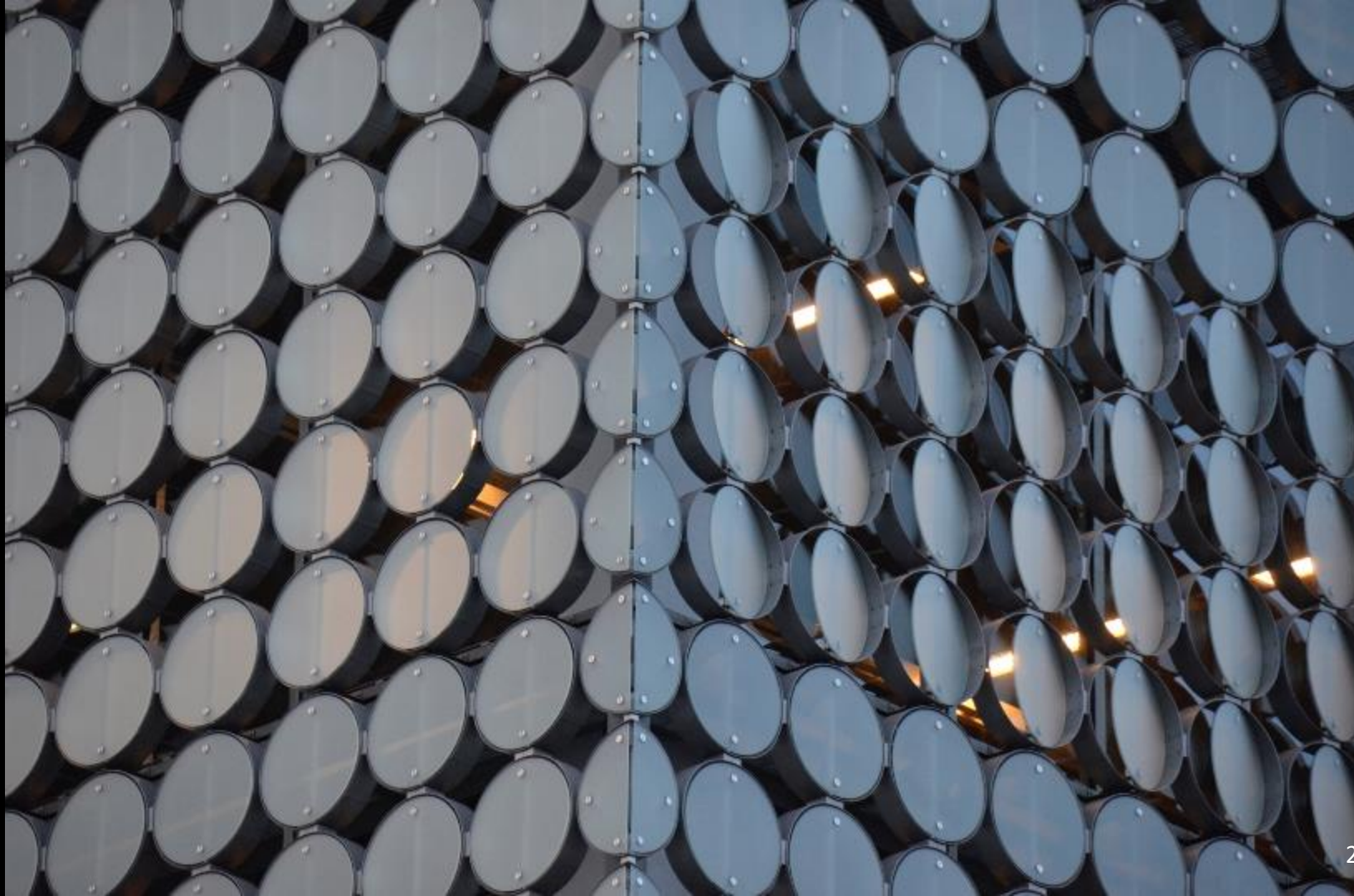



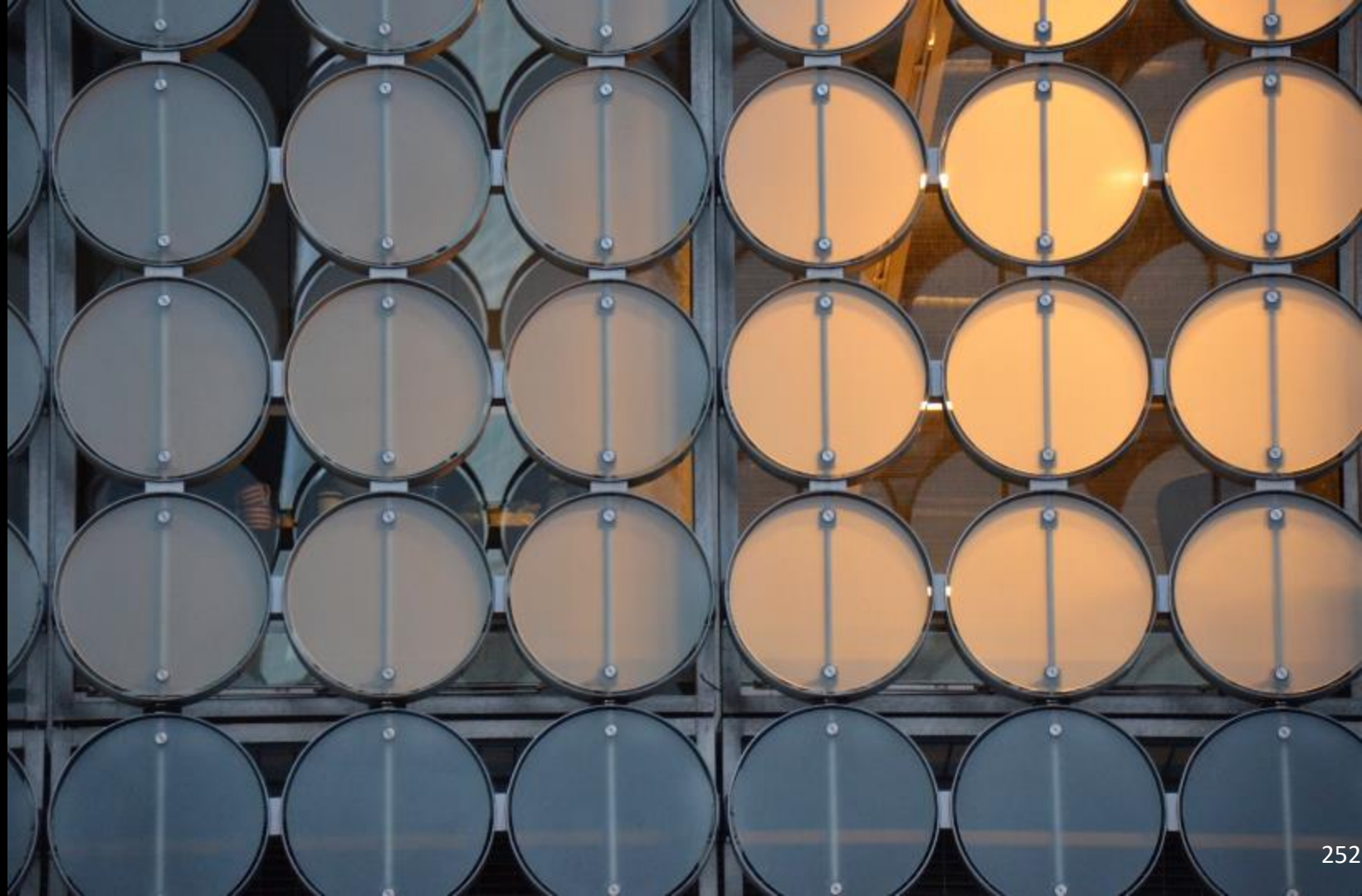





Various Projects  
Brisbane, Australia











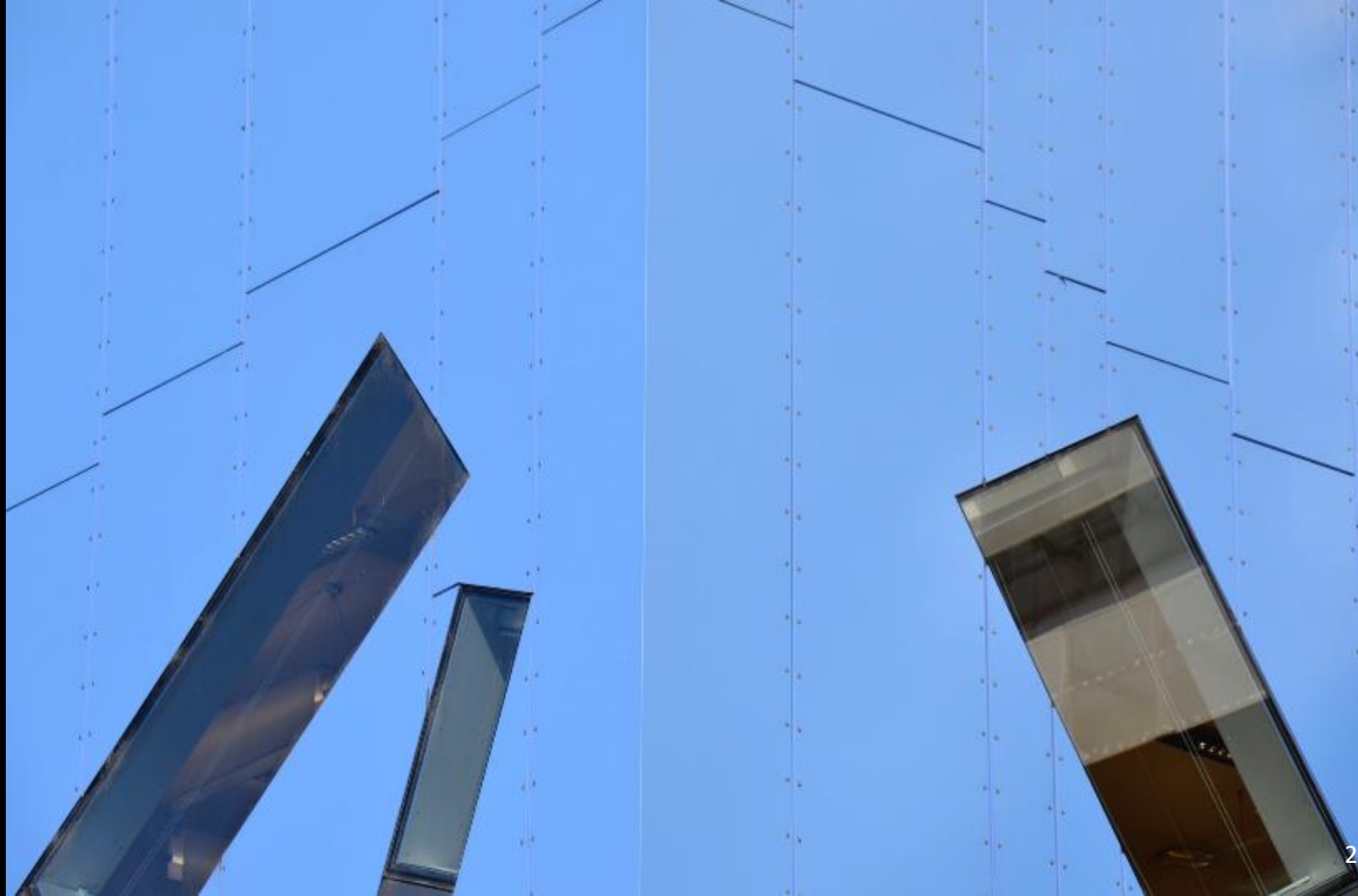













Various  
Sydney, Australia















# Precast Concrete Window Wall Systems







World Trade Center  
Dubai, UAE  
John R. Harris Associates  
1979

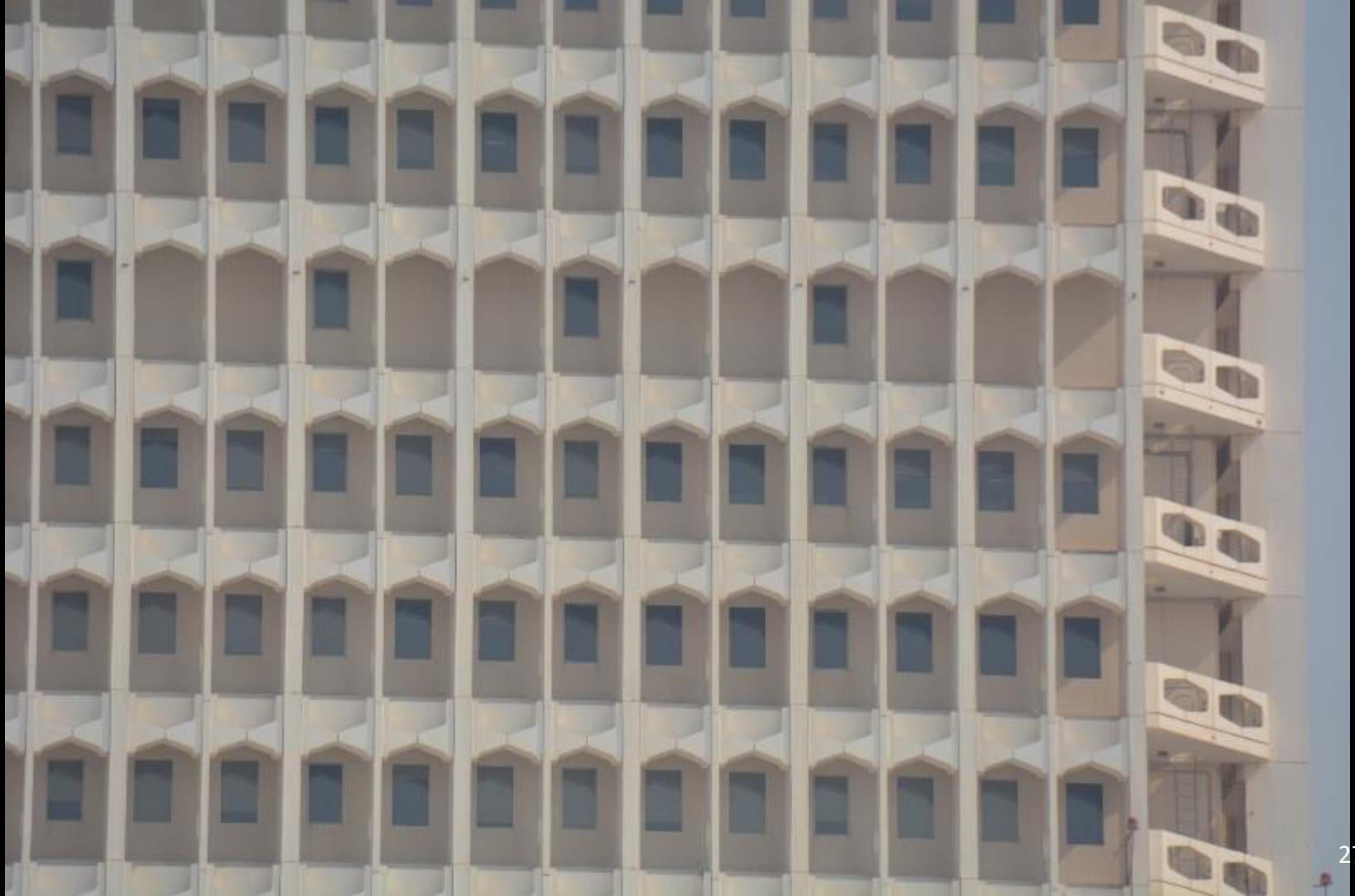





The Index  
Dubai, UAE  
Foster and Partners  
2010









# Stone Veneer Systems



Guangzhou Opera House  
Guangzhou, China  
Zaha Hadid Architects  
2010













# Fibre Reinforced Concrete

Fibre reinforced concrete is a type of concrete that includes fibrous substances that increase its structural strength and cohesion.

Fibre reinforced concrete has small distinct fibers that are homogeneously dispersed and oriented haphazardly.

Fibres used are steel fibers, synthetic fibres, glass fibres and natural fibres.



1 in. Crack  
Opening



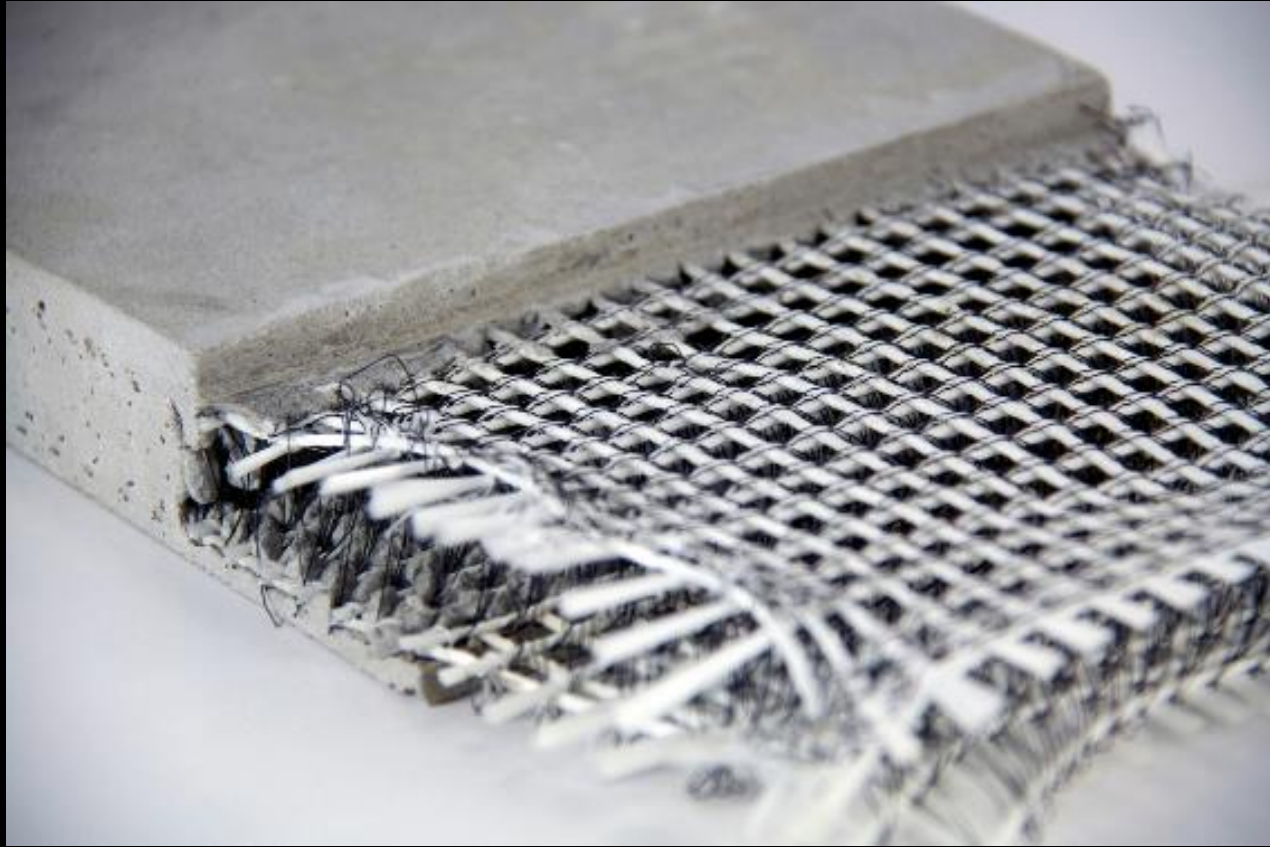









The FRP (fibre reinforced panels) are pretty thin, unlike precast concrete, and are often supported behind by a steel frame which is then attached to the building structure behind.



Academic Bridge Program  
Education City  
Doha, Qatar





Masdar Institute  
Foster and Partners  
Abu Dhabi, UAE  
2010







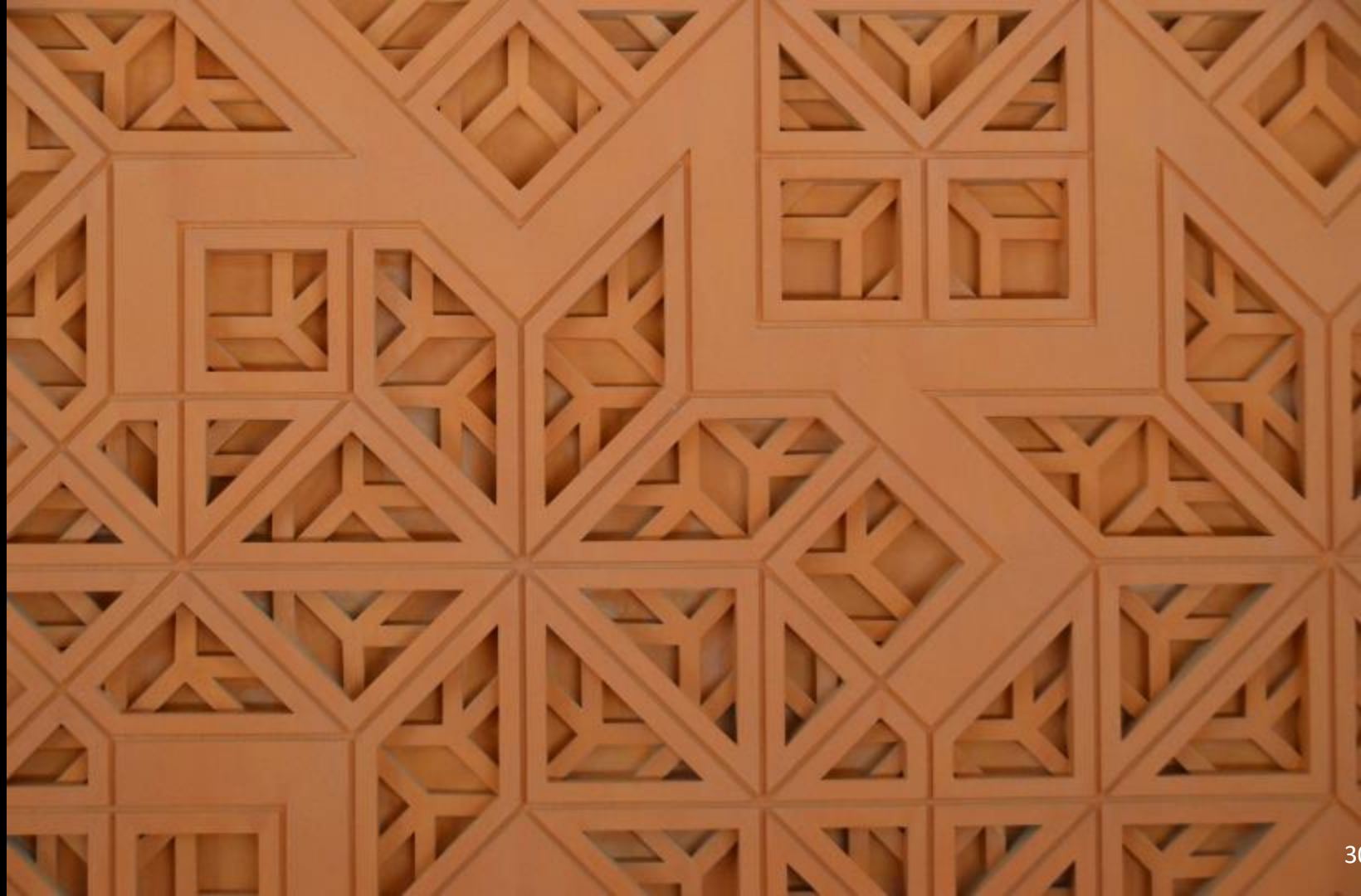





The Broad Museum  
Los Angeles, California  
Diller Scofidì + Renfro  
2015





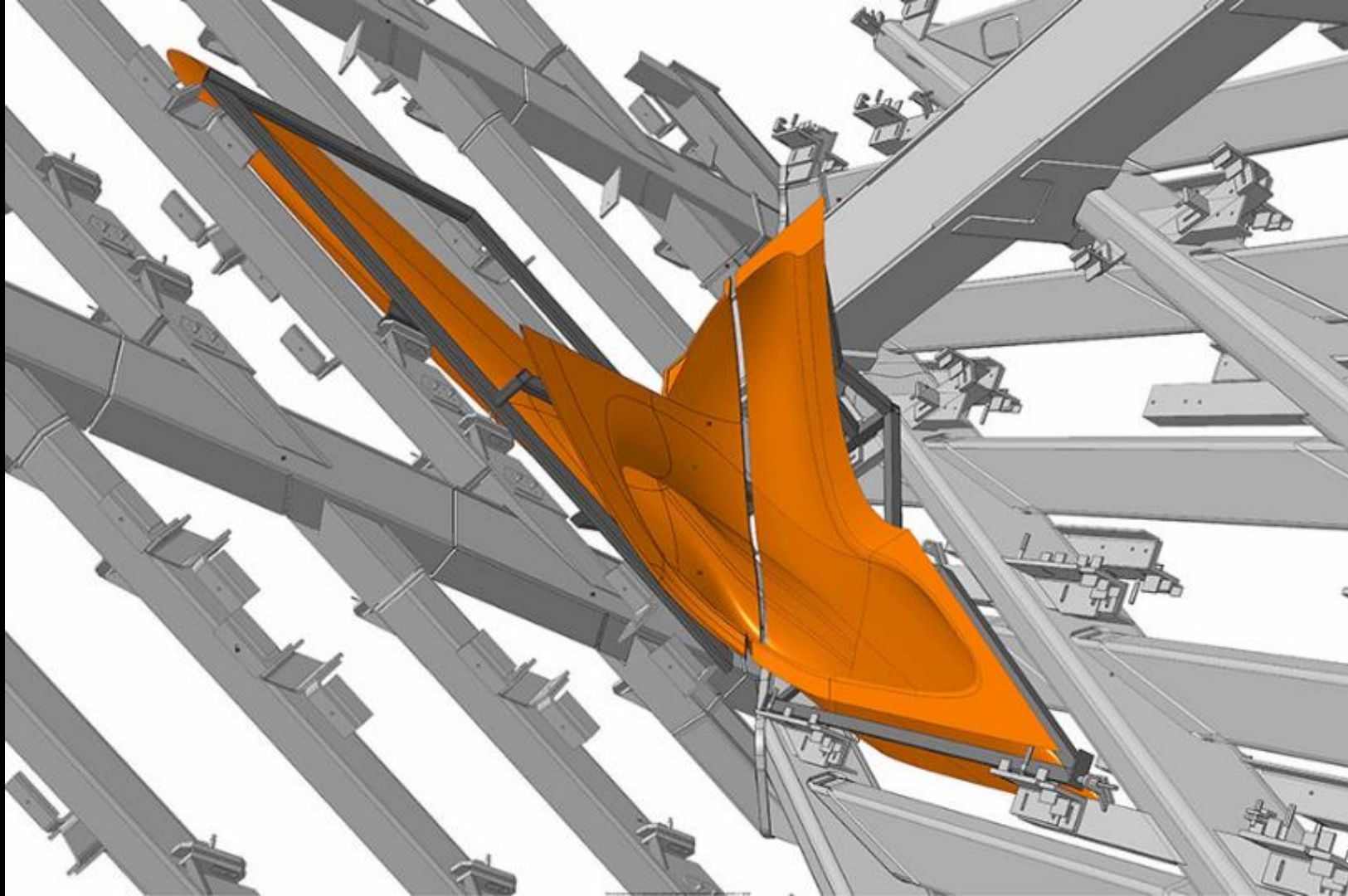

















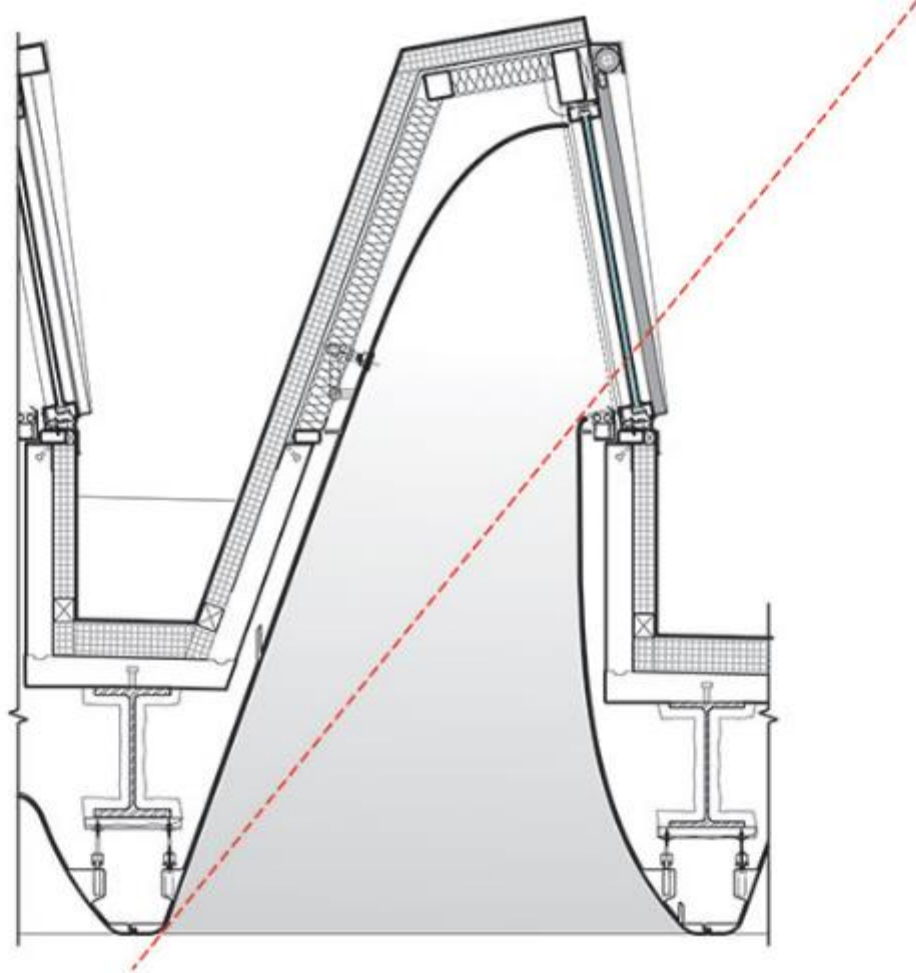

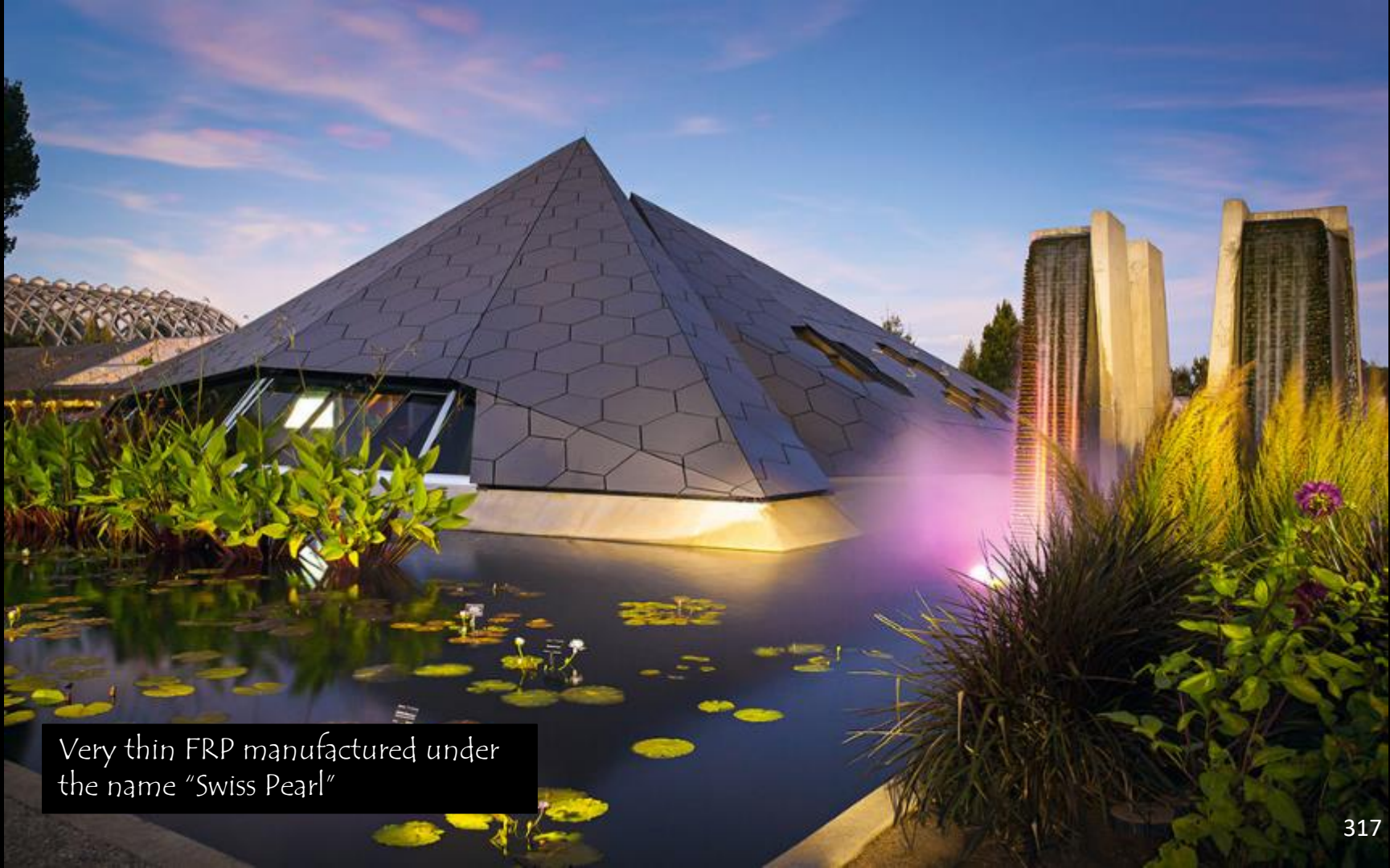

Very thin FRP manufactured under the name "Swiss Pearl"























## Horizontal section

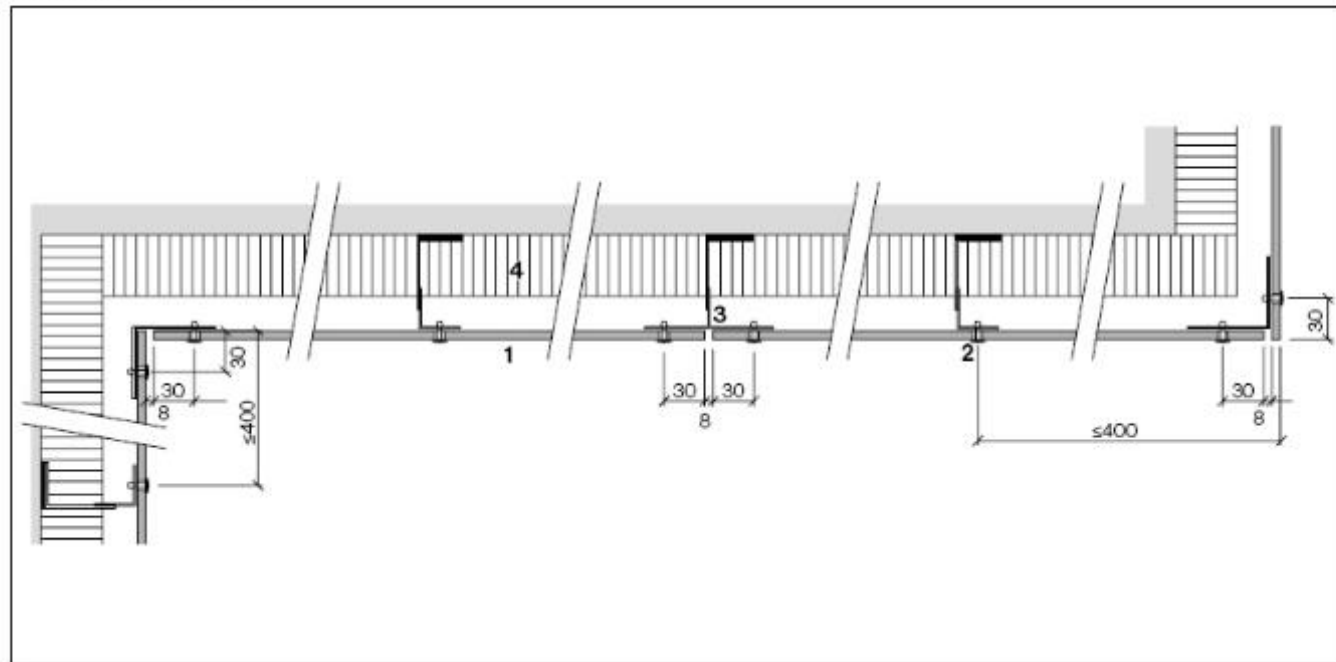

Panel may be cantilevered max.  
400 mm.

- 1 Swisspearl panel 8 mm
- 2 Rivet
- 3 Aluminum profile
- 4 Thermal insulation



## Design | Metal supports

### Example window jamb

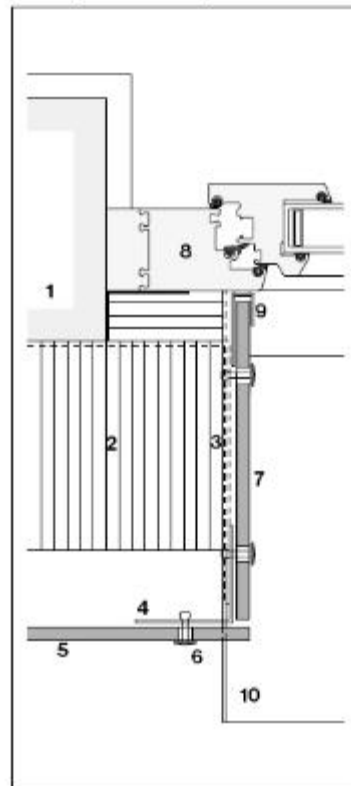

Jamb with 8 mm panel

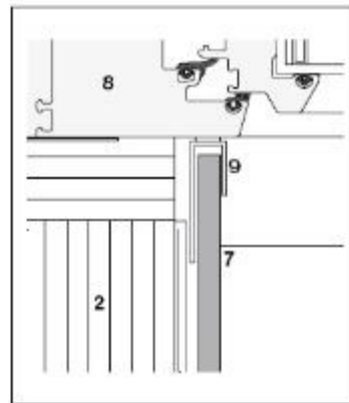

Window jamb with metal frame

- 1 Exterior wall
- 2 Thermal insulation
- 3 Horizontal support
- 4 Vertical support
- 5 Swisspearl panel 8 mm
- 6 Rivet 4.5x18 K15
- 7 Swisspearl jamb board 8 mm
- 8 Window frame
- 9 U or F-profile with sealant
- 10 Window sill

## Example window sill

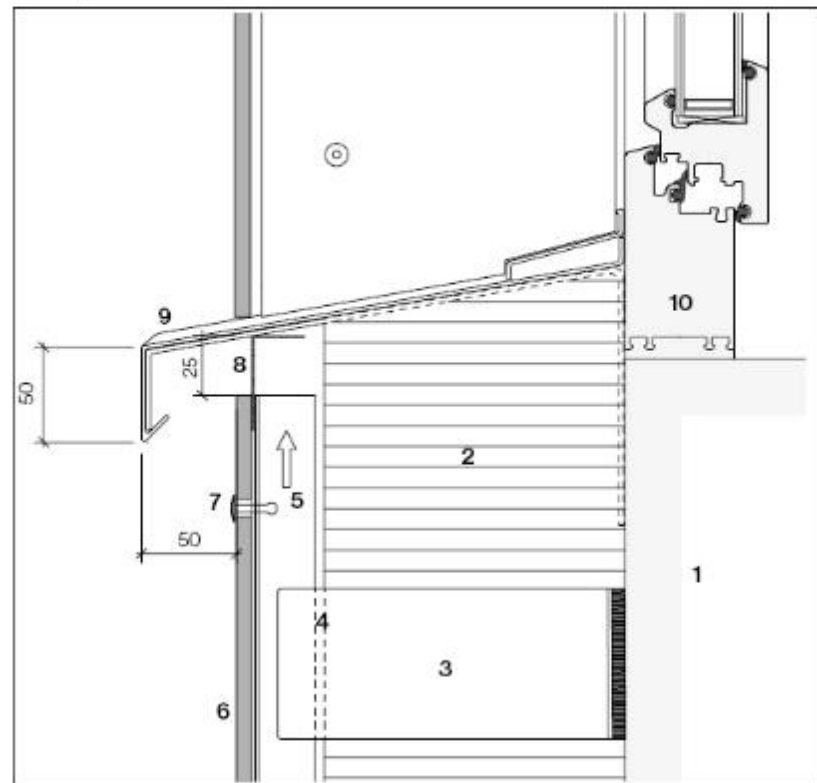

Window sill made of metal

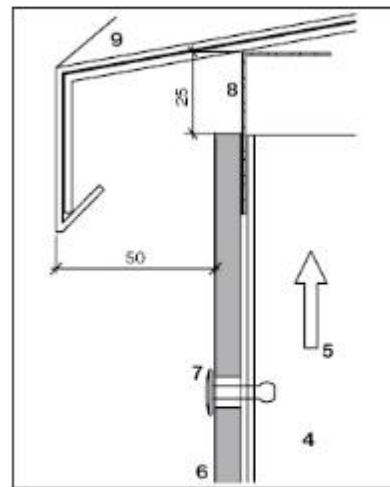

Sill detail

- 1 Exterior wall
- 2 Thermal insulation
- 3 Bracket
- 4 Vertical support
- 5 Ventilation cavity
- 6 Swisspearl panel 8 mm
- 7 Rivet 4.0x18-K15
- 8 Perforated angle
- 9 Window sill
- 10 Window frame

# Ceramic Fritted Glass

### Ceramic Fritted Glass:

- Silk screening onto glass improves solar control performance
- Can be combined with clear or tinted substrates
- Reduces glare
- Can be any pattern (cost dependent)

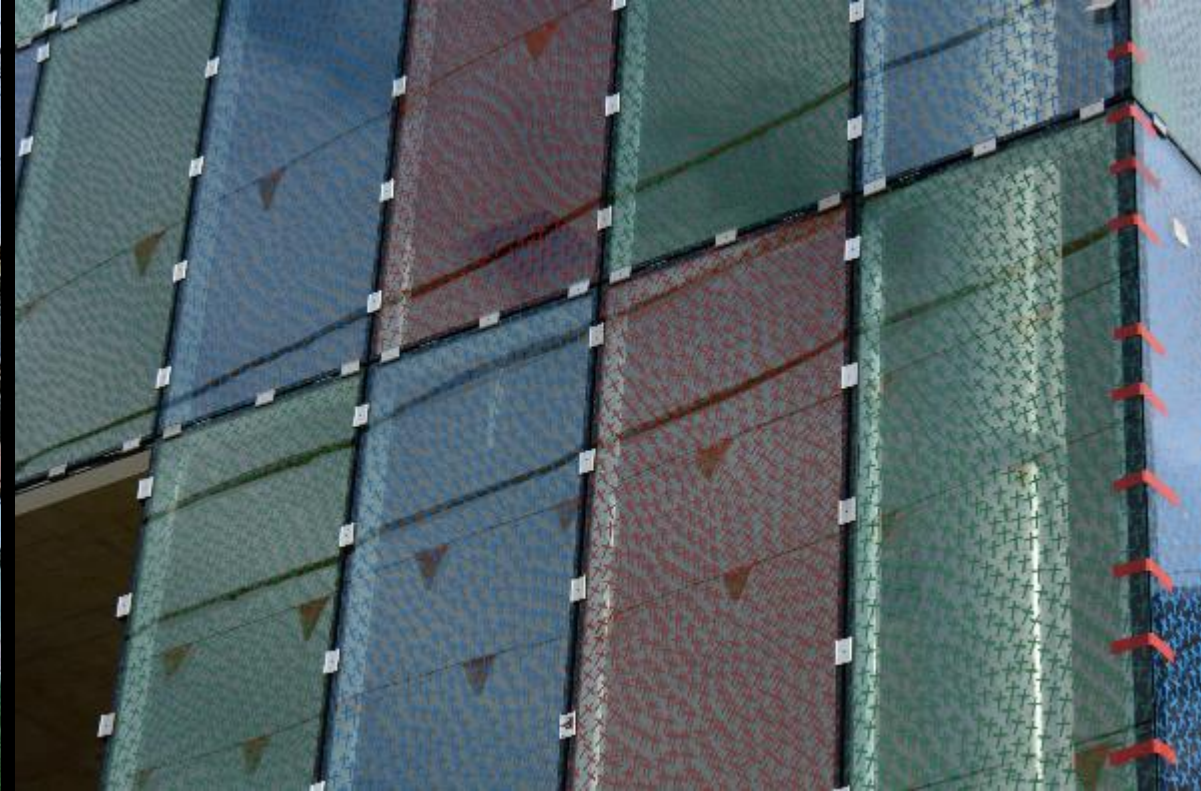





One New Change Shopping Centre  
London, England  
Ateliers Jean Nouvel



















Office Building  
Brisbane, Australia













Siemens HQ  
Masdar City, Abu Dhabi, UAE  
Sheppard Robson Architects  
2013





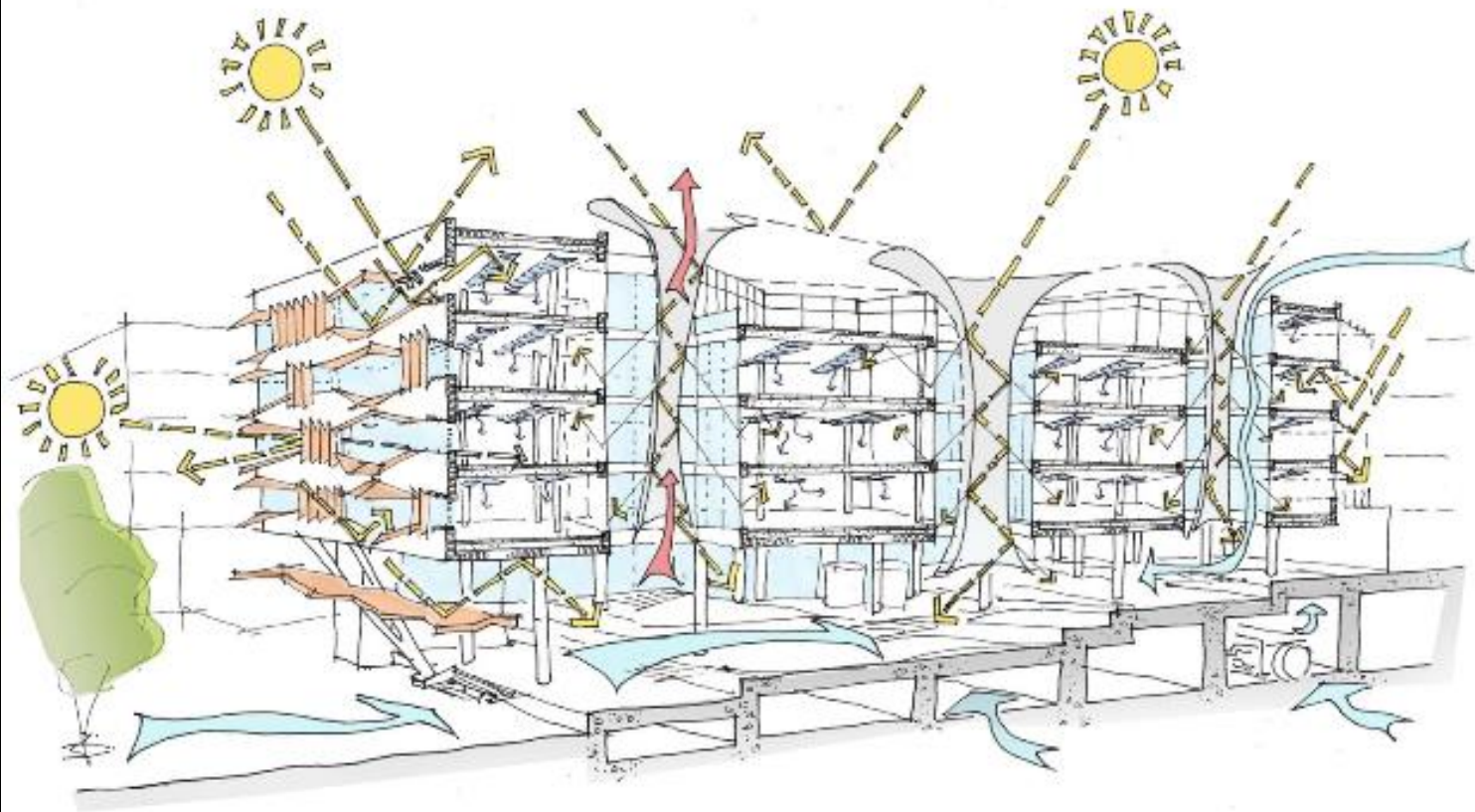

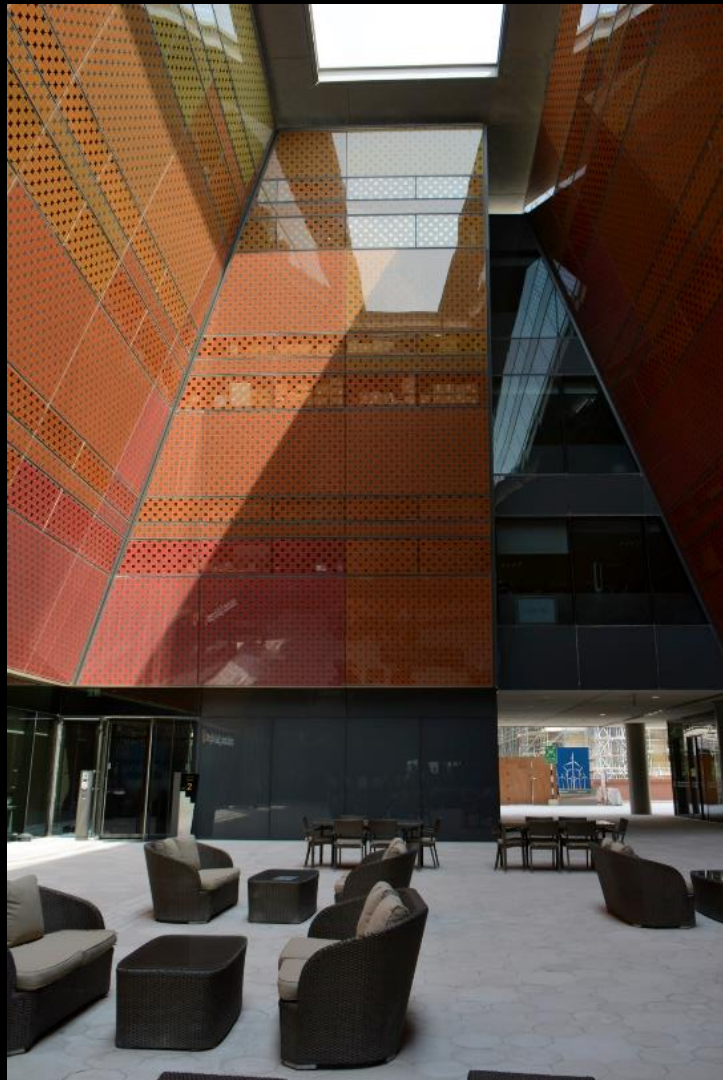





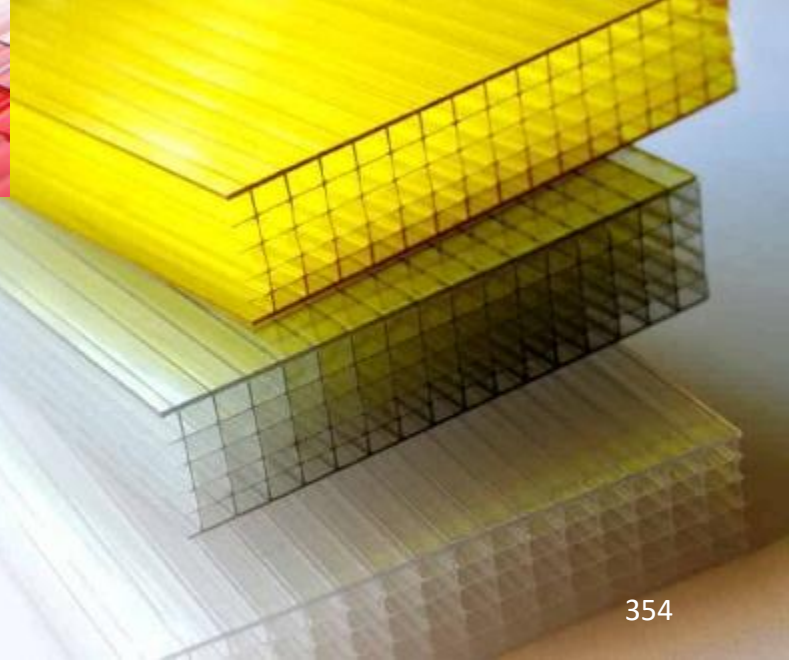
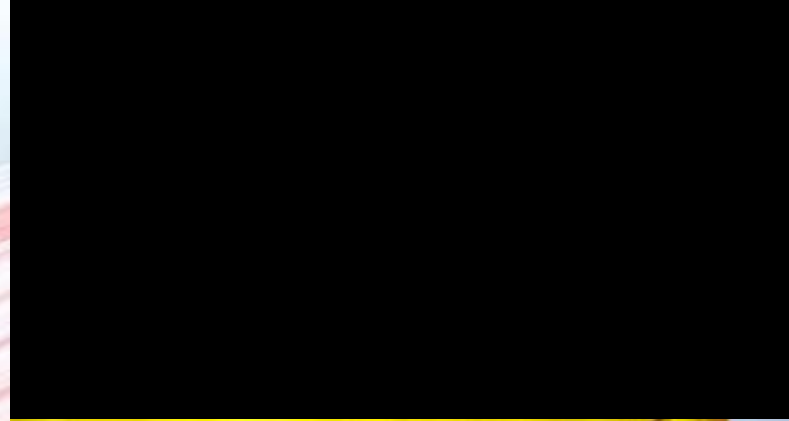
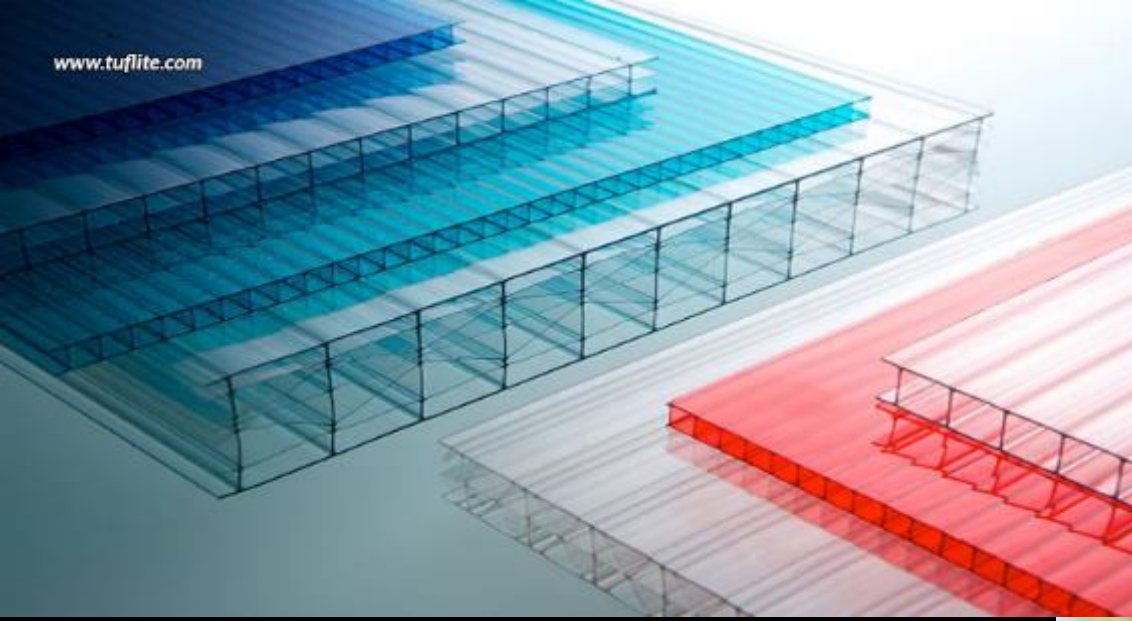

# Polycarbonate Panels

<https://danpal.com/polycarbonate-panels/>



Trinity Laban Dance Centre  
London, England  
Herzog & deMeuron























The Branley Museum  
Paris, France  
Ateliers Jean Nouvel



































People's Daily New Headquarters  
Beijing, China  
Southeast University School of Architecture  
2015













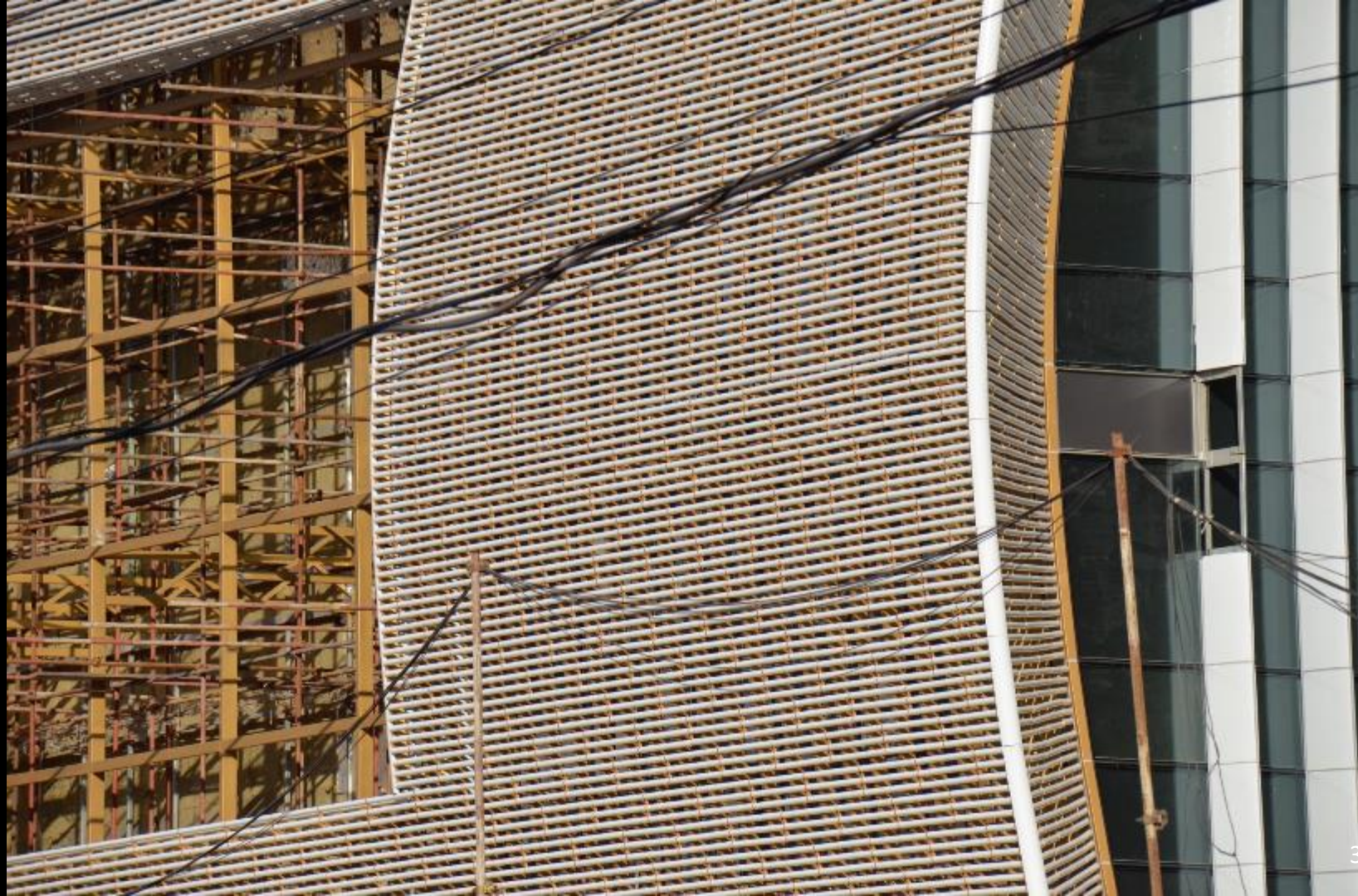









MAINTENANCE!!!

Can you actually clean it?

Capital Gate  
Abu Dhabi



Al Bahar Towers  
Abu Dhabi

